

3M Telecommunications

Solutions for Networks

Product Solution Guide

www.3Mtelecommunications.com



for Enterprise Networks

3M *Innovation*

Distributed Network

Fibre in the Backbone

The transmission capability of **fibre** makes it the ideal choice for the **backbone** since this is where the traffic is **concentrated**. Additionally, the superior distance capability of fibre makes it the ideal choice for cross campus links between building distributors.

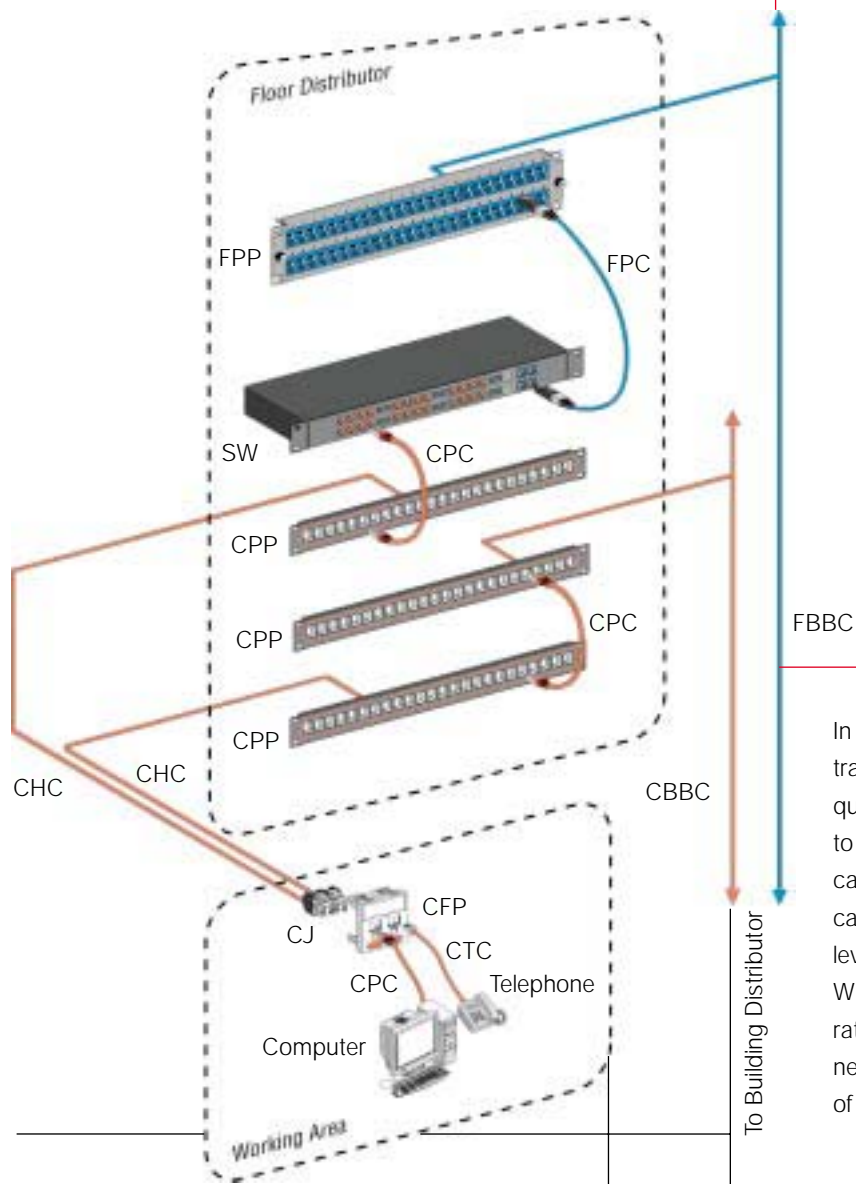

In the **horizontal** distribution, where traffic is less concentrated, **Category 5e** copper cabling meets all of today's requirements, adequately supporting transmission speeds up to 1Gbps. Looking to the future, the increased performance capability of the **Category 6** system means that new applications are also likely to be supported thus providing a high level of confidence that the network will last for many years. Where there are special requirements relating to the operating environment (**security** requirements, electrical **noise**, need for **long link lengths** or high **bandwidth** etc.), the use of **fibre** throughout the network should be considered.

Item		Page
CPC	• Copper Patch Cable	29
CFP	• Copper Face Plate	26
CJ	• Copper Jack	24
CTC	• Copper Telephone Cord	31
CHC	• Copper Horizontal Cable	28
SW	• Switch	35
CPP	• Copper Patch Panel	27
FPC	• Fibre Patch Cord	21
FBBC	• Fibre Backbone Cable	18
CBBC	• Copper Backbone Cable	29

Zone Distribution

Fibre to the Zone

Extending **fibre** out into the **horizontal** distribution provides an **economical** alternative to installing fibre throughout the network. This architecture is particularly beneficial in situations where multiple users need network access and there are cable containment issues. It also provides a **convenient upgrade** path for high bandwidth applications. Typical examples of where this architecture would be of benefit would be **conference rooms** and **classrooms**. In such cases a simple un-managed switch would provide the copper/fibre conversion. Users would access the network using copper work area cords.

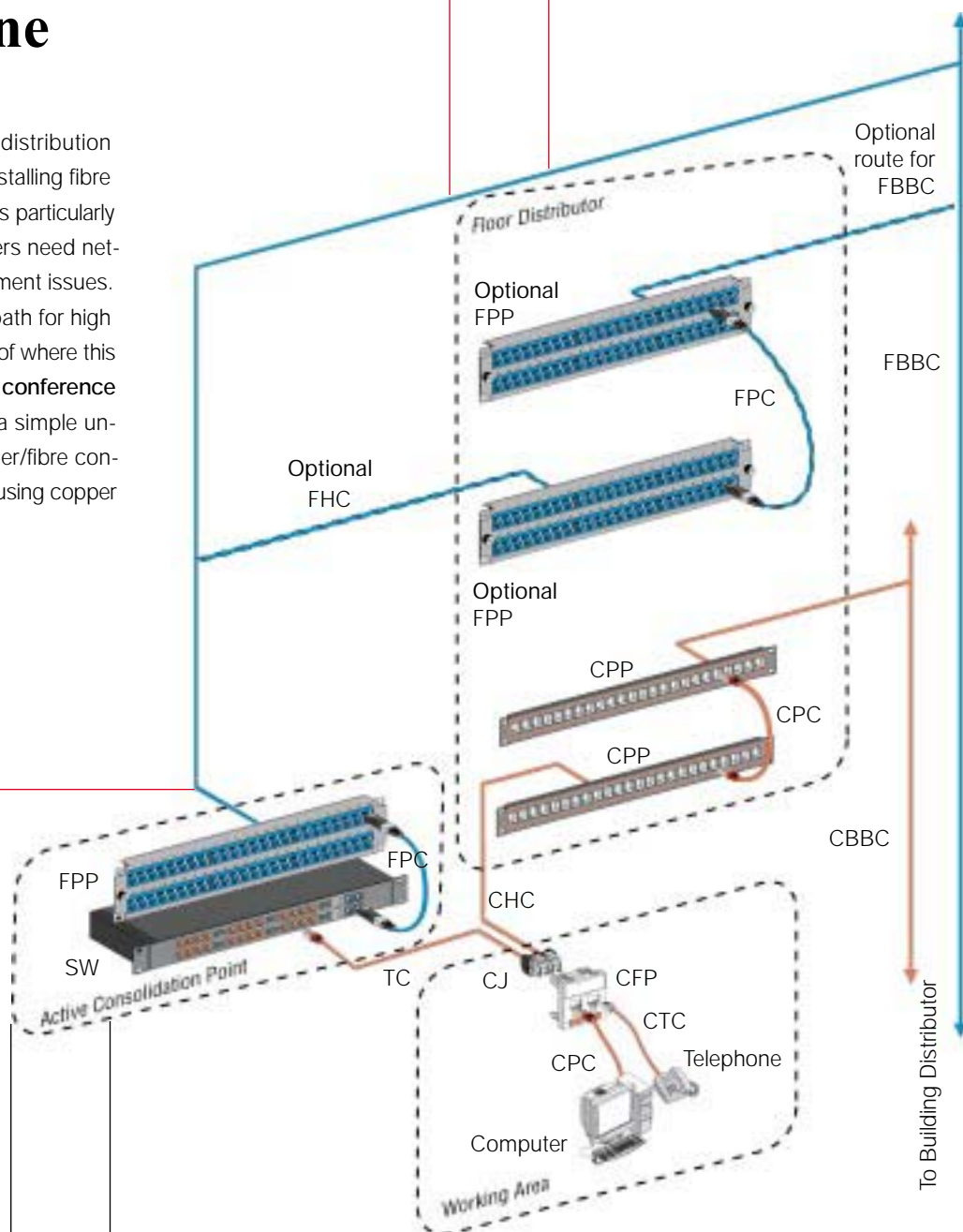

Item		Page
CPC	• Copper Patch Cable	29
CTC	• Copper Telephone Cord	31
FC	• Fibre Connector	14
CJ	• Copper Jack	24
FHC	• Fibre Horizontal Cable	17
CHC	• Copper Horizontal Cable	28
CPP	• Copper Patch Panel	27
FPP	• Fibre Patch Panel	16
FBBC	• Fibre Backbone Cable	18
CBBC	• Copper Backbone Cable	29

Centralized Network Solutions

FTTD - The Home Run

The Home Run - two or four fibre horizontal cable serving the work area is pulled from the telecommunications outlet (TO) all the way back to the building distributor (BD). A modular insulation displacement connector (IDC) block is used to provide a flexibility point for the copper voice cables only, therefore eliminating the need for a floor distributor (FD). The block is mounted on a compact back mount frame that can be supplied in a variety of configurations (free standing, wall supported or wall mounted). The IDC block is useful for adding and removing services when required.

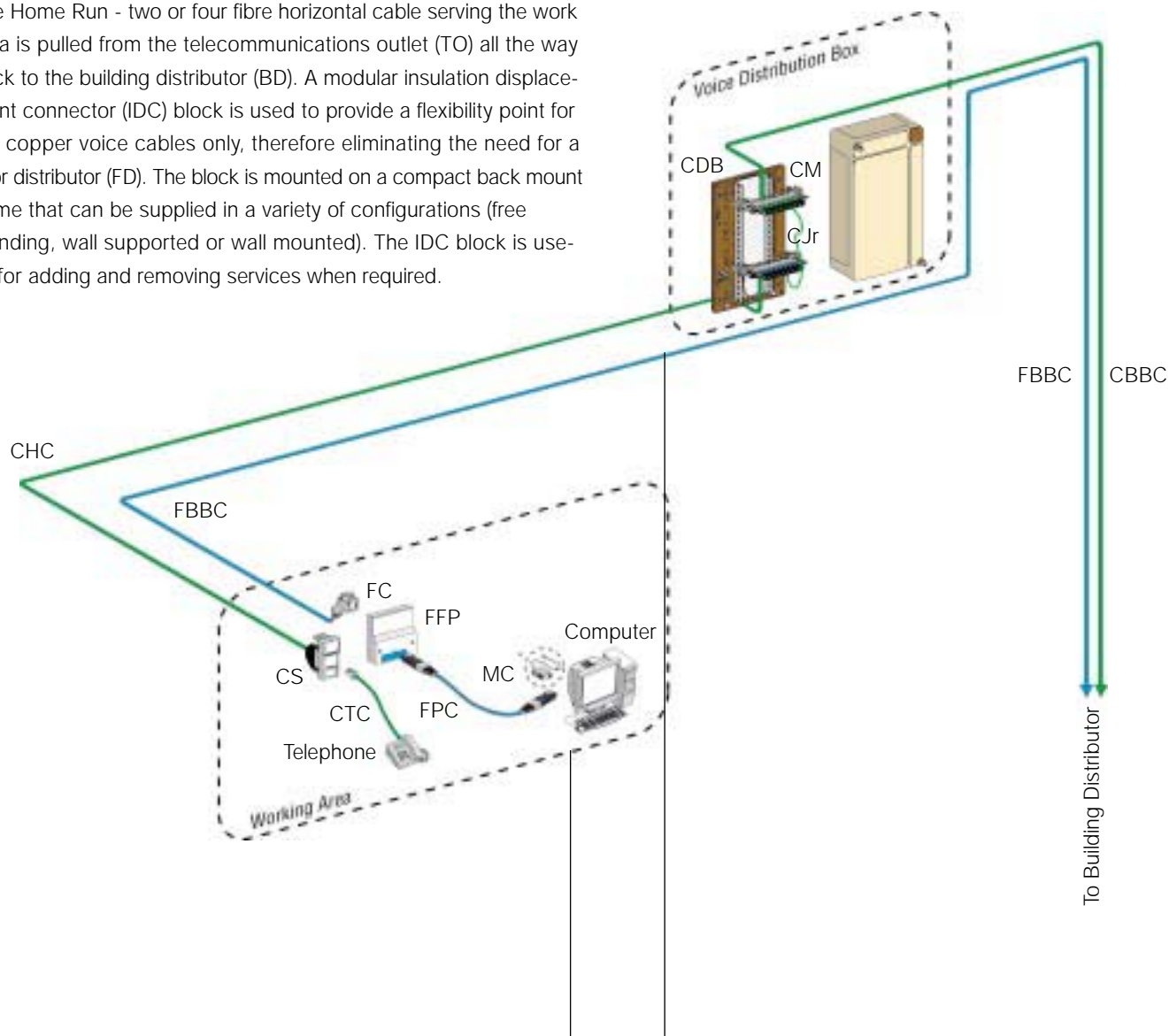

Item		Page
FPC	• Fibre Patch Cord	21
FFP	• Fibre Face Plate	16
FC	• Fibre Connector	14
FBBC	• Fibre Backbone Cable	18
CTC	• Copper Telephone Cord	31
CS	• Copper Socket	24
CHC	• Copper Horizontal Cable	28
CDB	• Copper Distribution Box	34
CM	• Copper Module	25
CJr	• Copper Jumper	Customer Supplied
CBBC	• Copper Backbone Cable	29
MC	• Media Converter (optional)	35

Centralized Network Solutions

FTTD - The Home Run with Splice Point

Similar to the Home Run, in this architecture a splice is added to breakout high fibre count backbone cable originating at the building distributor (BD), into two or four fibre horizontal cable serving the work area.

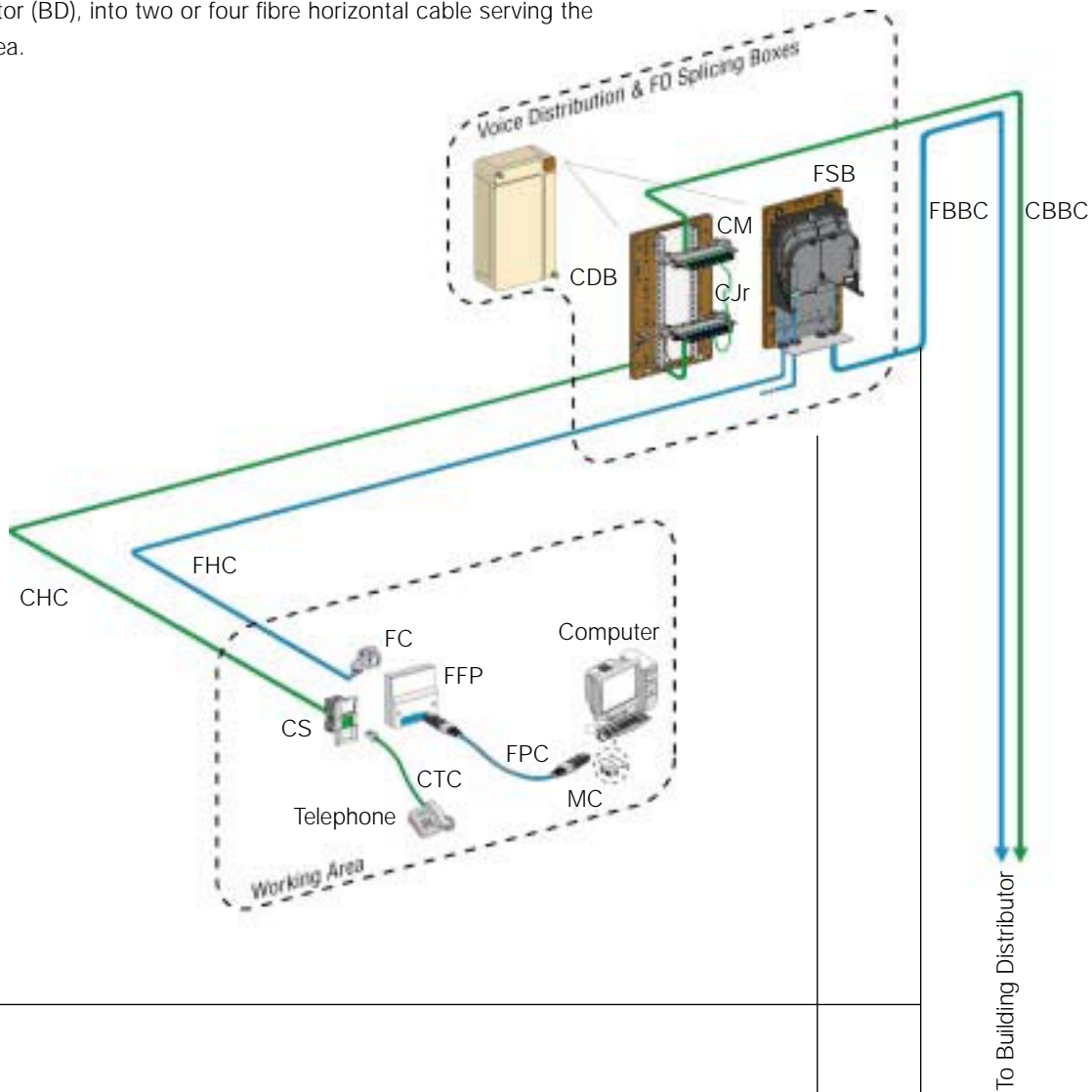

Item		Page
FPC	• Fibre Patch Cord	21
FFP	• Fibre Face Plate	16
FC	• Fibre Connector	14
FHC	• Fibre Horizontal Cable	17
FSB	• Fibre Splice Box	17
FBBC	• Fibre Backbone Cable	18
CTC	• Copper Telephone Cord	31
CS	• Copper Socket	24
CHC	• Copper Horizontal Cable	28
CDB	• Copper Distribution Box	34
CM	• Copper Module	25
CJr	• Copper Jumper	Customer Supplied
CBBC	• Copper Backbone Cable	29
MC	• Media Converter (optional)	35

Centralized Network Solutions



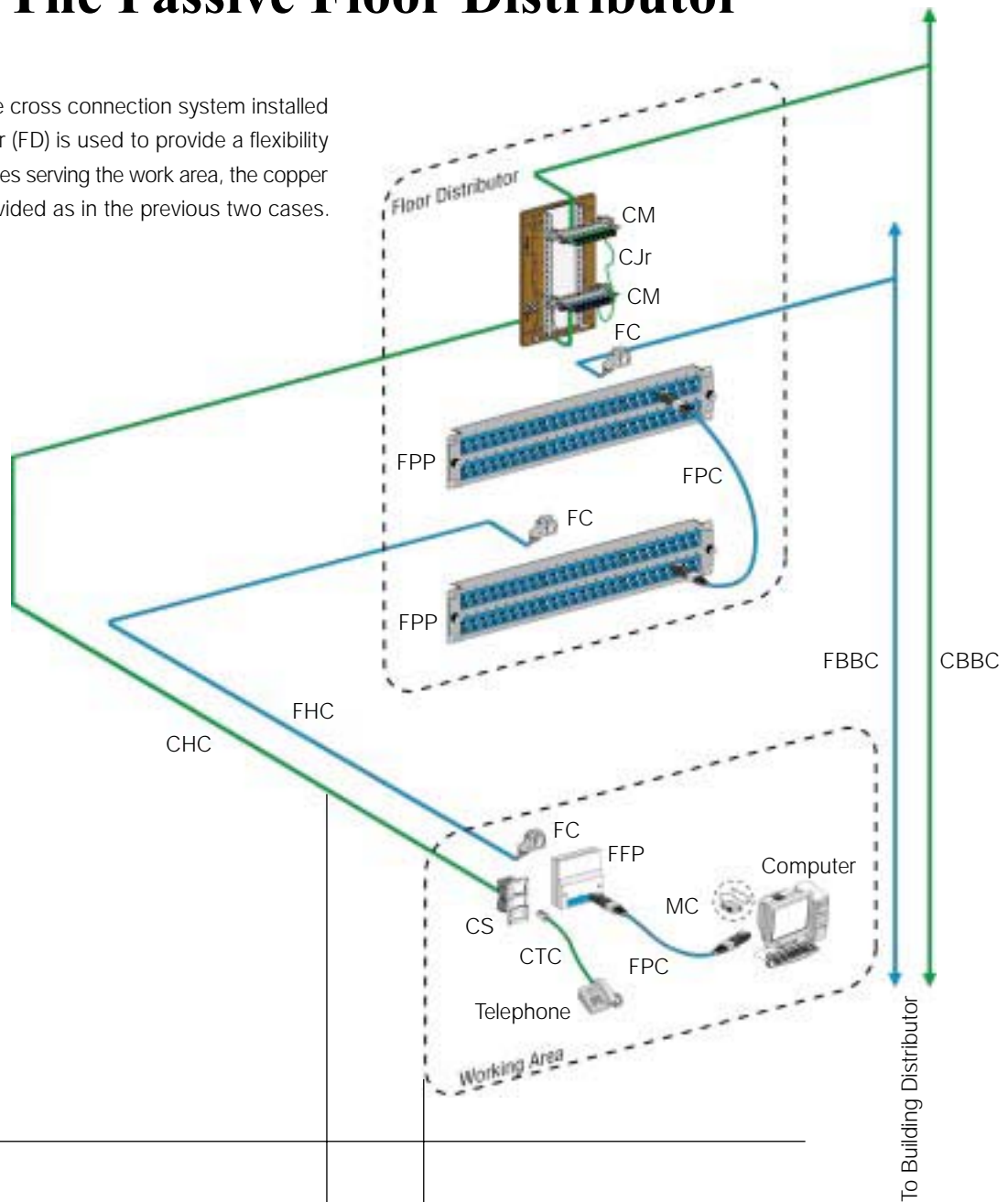

FTTD - The Passive Floor Distributor

In this case a passive cross connection system installed in the floor distributor (FD) is used to provide a flexibility point for the fibre cables serving the work area, the copper voice cables are provided as in the previous two cases.



Item		Page
FPC	• Fibre Patch Cord	21
FPP	• Fibre Face Plate	16
FC	• Fibre Connector	14
FHC	• Fibre Horizontal Cable	17
FPP	• Fibre Patch Panel	16
CTC	• Copper Telephone Cord	31
CS	• Copper Socket	24
CHC	• Copper Horizontal Cable	28
CJ	• Copper Jack	24
CPP	• Copper Patch Panel	27
MC	• Media Converter (optional)	35
FBBC	• Fibre Backbone Cable	18
CBBC	• Copper Backbone Cable	29

Fibre Components

Description	Ref.-No
FC - Fibre Connectors	
<i>VF-45™ Socket Range</i>	
VF-45™ Socket, multimode	VOL-0001
VF-45™ Socket, singlemode	VOL-0002
VF-45™ Socket fibre holder	VOL-0011
VF-45™ Socket fibre holder, 900µm	VOL-0011A
	
<i>ST product range</i>	
<i>ST Hot-Melt multimode</i>	
ST Hot-Melt Connector, multimode, 125µm, white boot	6100-W
ST Hot-Melt Connector, multimode, 125µm, red boot	6100-R
ST Hot-Melt Connector, multimode, 125µm, black boot	6100-B
<i>ST Crimplok™ multimode</i>	
ST Crimplok™ Connector, multimode, 125µm	6901
<i>ST Hot-Melt singlemode</i>	
ST Hot-Melt Connector, singlemode, 126µm, yellow boot	8100-YS
<i>ST Epoxy multimode</i>	
ST Epoxy Connector, multimode, 125µm, black boot	6105-B
ST Epoxy Connector, multimode, 125µm, red boot	6105-R
<i>ST Epoxy singlemode</i>	
ST Epoxy Connector, singlemode 126µm, yellow boot	8106
ST Epoxy Connector, singlemode 127µm, yellow boot	8107
	
<i>SC product range</i>	
<i>SC Hot-Melt multimode</i>	
SC Hot-Melt Connector, multimode 125µm, white boot	6300-W
SC Hot-Melt Connector, multimode 125µm, white boot	6300-W5-12
<i>SC Hot-Melt singlemode</i>	
SC Hot-Melt Connector, singlemode 126µm, white boot	8300
<i>SC Crimplok™ multimode</i>	
SC Crimplok™ Connector, multimode 125µm	6900
<i>SC Epoxy multimode</i>	
SC Epoxy Connector, multimode 125µm, beige boot	6306-BE
<i>SC Epoxy singlemode</i>	
SC Epoxy Connector, singlemode 126µm, white boot	8306
SC Epoxy Connector, singlemode 127µm, white boot	8307
	
<i>FC Product range</i>	
<i>FC Hot-Melt multimode</i>	
FC Hot-Melt Connector, multimode 125µm, white boot	6200
<i>FC Epoxy multimode</i>	
FC Epoxy Connector, multimode 125µm, white boot	6202
<i>FC Epoxy singlemode</i>	
FC Epoxy Connector, singlemode 126µm, white boot	8203
FC Epoxy Connector, singlemode 127µm, white boot	8204
	

Fibre Components

Description	Ref.-No
ST Couplings	
<i>Multimode ST Couplings</i>	
ST/ST Coupling simplex, multimode, threaded with panel nut and lock washer	6112
ST/ST Coupling simplex, multimode, threaded	6113
<i>Singlemode ST Couplings</i>	
ST/ST Coupling duplex, singlemode, threaded	8113
ST/ST Coupling simplex, singlemode, threaded with panel nut and lock washer	8119
ST/ST Coupling simplex, singlemode, metal	7441
<i>Hybrid Couplings</i>	
SC/ST hybrid Coupling duplex, multimode	ST/SC MM
SC/ST hybrid Coupling duplex, singlemode	ST/SC SM
SC Couplings	
<i>Multimode SC Couplings</i>	
SC/SC Coupling duplex, multimode, blue	6313
SC/SC Coupling duplex, multimode, metal body	6313M
SC/SC Coupling simplex, multimode	6310
<i>Singlemode SC Couplings</i>	
SC/SC Coupling duplex, singlemode	8313
SC/SC Coupling simplex, singlemode	8310
FC Couplings	
FC/PC-FC/PC Coupling simplex, singlemode, Square flanged	8210
FC/PC-FC/PC Coupling simplex, singlemode, D mount	8211



Fibre Components

Description	Ref.-No
FS - Fibre Splice	
Single-fibre Fibrlok™ splice	
2529 Fibrlok II Universal optical fibre splice, 250 X 900	84871
2529 Fibrlok II Universal optical fibre splice, 250 X 900	84402
Multi-fibre Fibrlok™ splice	
2604 Fibrlok multi-fibre optical splice (4 fibres)	84558
2612 Fibrlok multi-fibre optical splice (12 fibres)	83469
	
FFP - Fibre Faceplates	
Volition™ Wall Faceplates	
Wall outlet, 80mm x 80mm, office white - Europe	VOL-0255W
Wall outlet, 86mm x 86mm, office white - Europe	VOL-0256W
Wall outlet, 80mm x 80mm , cream white - Europe	VOL-0255C
Wall outlet, Module 45mm x 90mm, office white	VOL-0257W
Wall outlet, 210mm x 160mm x 60mm, white, 6-port	2552 SA VF-45
	
ST Wall Faceplate	
for 2 x ST-Simplex (30 degree)	FIPTOST-70
for 4 x ST-Simplex	FIPTOST-80
SC Wall Faceplate	
for 2 x SC-Duplex	FIPTOSC-80
for 2 x SC-Duplex (30 degree)	FIPTOSC-70
Volition™ Floor inserts (for Ackermann Tank GES(R) 2,4,6,7,9)	
Floortank Insert, Ackermann 3 x VF-45, 3 x Quante RJ45	VOL-0259 A
Floortank Insert, Ackermann 3 x VF-45, 3 x Panduit RJ45	VOL-0259 B
Floortank Insert, Ackermann 3 x VF-45, 2 x IBM RJ45	VOL-0259 C
	
FPP - Fibre Patch Panels	
Volition™ 19" Patch Panels	
Patch Panel, sliding, 24 port 1U	VOL-0430-ES
Patch Panel, sliding, 48 port 2U	VOL-0432-ES
Patch Panel, sliding, 72 port 3U	VOL-0434-ES
Patch cord management Panel	VOL-0499-E
	
ST and SC 19" Patch Panels , empty without faceplate	
19" Splice drawer sliding, 1U, empty for 12 ST	DE-0100-0954-1
19" Splice drawer sliding, 1U, empty for 24 ST	DE-0100-0955-8
19" Splice drawer sliding, 1U, empty for 24 SC-Duplex	DE-0100-1319-6
19" Splice drawer sliding, 1U, empty for 12 SC-Duplex	DE-0100-0957-4
19" Splice drawer sliding, 1U, empty for 6 SC-Duplex	DE-0100-1225-5

Fibre Components

Description	Ref.-No
ST and SC 19" Patch Panels , with couplings and faceplate	
19" Splice drawer sliding, 1U, with 12 ST Couplings MM	DE-0100-0679-4
19" Splice drawer sliding, 1U, with 24 ST Couplings MM	DE-0100-0680-2
19" Splice drawer sliding, 1U, with 12 ST/SC-Duplex Coupling MM	DE-0100-0681-0
19" Splice drawer sliding, 1U, with 24 ST/SC-Duplex Coupling MM	TBD
Blanking Plugs for Volition™ Outlets and Patch Panels	
Blank insert - office white	VOL-0300
Blank insert - bright white	VOL-0300B
Volition™ Wall mount Patch Panels	
Wall mount Patch Panel, 6 port, w/ bezels	VOL-0406B
Wall mount Patch Panel, 12 port, w/ bezels	VOL-0412B
Wall mount Patch Panel, 24 port, w/ bezels	VOL-0424B
FSB - Fibre Splice Box	
Type I: 48 - 96 Fibres, 300 x 300 x 85mm	
Type II: 144 - 288 Fibres, 225 x 600 x 220mm	
Type III: 288 - 576 Fibres, 425 x 600 x 210mm	
Type IV: 288 - 864 Fibres, 650 x 600 x 210mm	
FHC - Fibre Horizontal Cable	
50/125µm multimode	
Horizontal 50/125µm, 2 fibre LSZH, 1km	VOL-H52L1
Horizontal 50/125µm, 4 fibre LSZH, 1km	VOL-H54L1
Horizontal 50/125µm, 2 fibre LSZH, 2km	VOL-H52L2
Horizontal 50/125µm, 4 fibre LSZH, 2km	VOL-H54L2
62.5/125µm multimode	
Horizontal 62.5/125µm, 2 fibre LSZH, 1km	VOL-H62L1
Horizontal 62.5/125µm, 4 fibre LSZH, 1km	VOL-H64L1
9/125µm singlemode	
Horizontal singlemode 2 fibre 9/125µm LSZH	VOL-H92L1
Horizontal singlemode 4 fibre 9/125µm LSZH	VOL-H94L1
Hybrid multimode/singlemode	
Horizontal Hybrid 2 fibre 9/125µm & 2 fibre 50/125µm LSZH	VOL-H954L1
Horizontal Hybrid 2 fibre 9/125µm & 2 fibre 62.5/125µm LSZH	VOL-H964L1

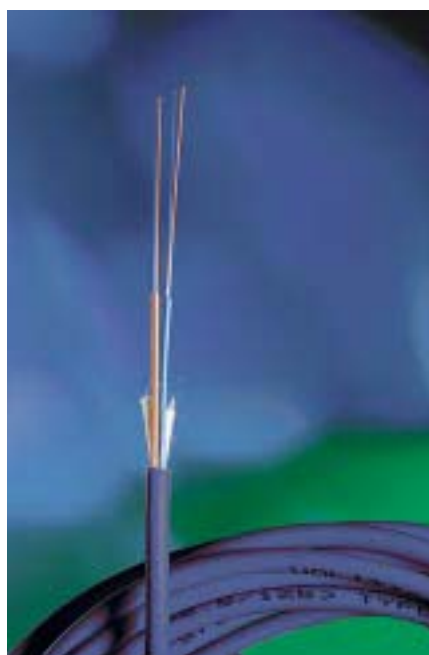

Fibre Components

Description

Ref.-No

FBBC - Fibre Backbone Cable

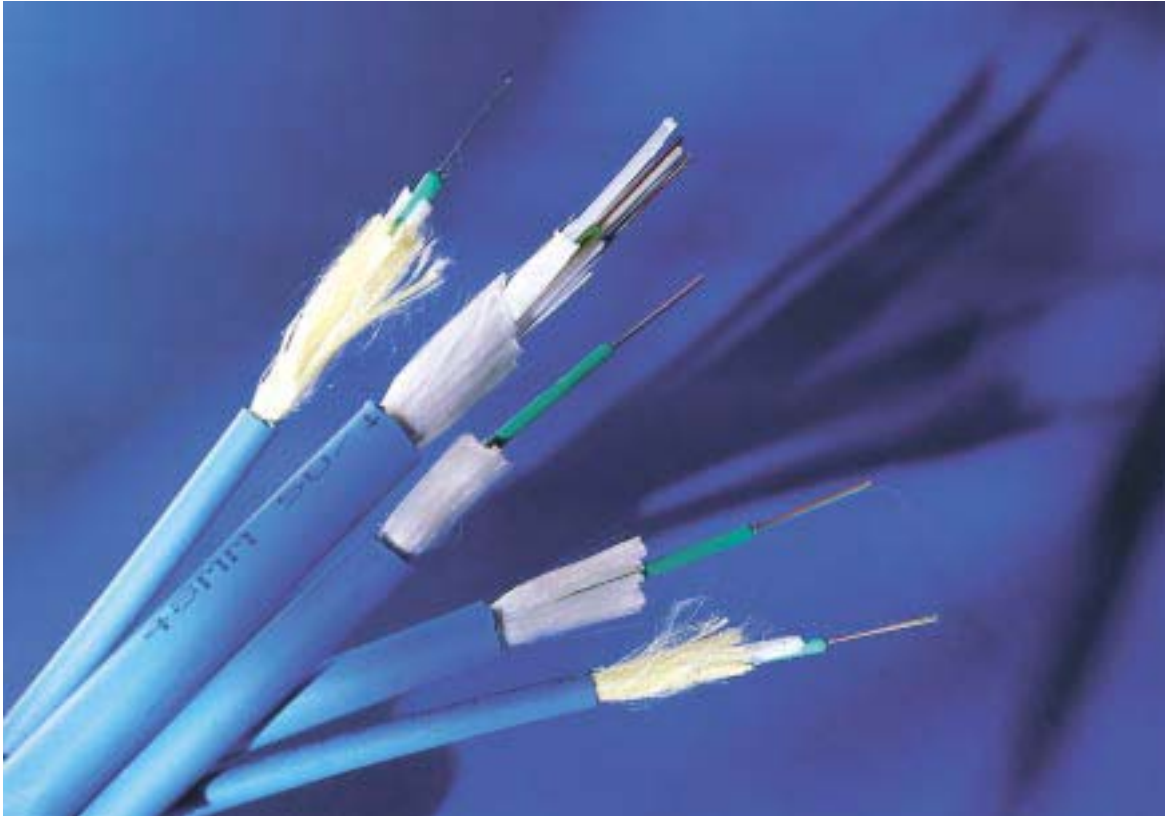

Backbone Indoor Cable, 50/125µm multimode

6 fibre LSZH
12 fibre LSZH
24 fibre LSZH
48 fibre LSZH
72 fibre LSZH
96 fibre LSZH

VOL-B 56
VOL-B 512
VOL-B 524
VOL-B 548
VOL-B 572
VOL-B 596

Backbone Indoor Cable, 62.5/125µm multimode

6 fibre LSZH
12 fibre LSZH
24 fibre LSZH
48 fibre LSZH
72 fibre LSZH
96 fibre LSZH

VOL-B 66
VOL-B 612
VOL-B 624
VOL-B 648
VOL-B 672
VOL-B 696

Backbone Indoor Cable, 9/125µm singlemode

6 fibre LSZH
12 fibre LSZH
24 fibre LSZH
48 fibre LSZH
72 fibre LSZH
96 fibre LSZH

VOL-B 96
VOL-B 912
VOL-B 924
VOL-B 948
VOL-B 972
VOL-B 99

Fibre Components

Description	Ref.-No
<i>Backbone Indoor / Outdoor Cable, Aramid, 50/125µm multimode</i>	
2 fibre Unitube, gel filled w/ aramid yarn LSZH	VOL-IO A52
4 fibre Unitube, gel filled w/ aramid yarn LSZH	VOL-IO A54
6 fibre Unitube, gel filled w/ aramid yarn LSZH	VOL-IO A56
8 fibre Unitube, gel filled w/ aramid yarn LSZH	VOL-IO A58
12 fibre Unitube, gel filled w/ aramid yarn LSZH	VOL-IO A512
24 fibre Unitube, gel filled w/ aramid yarn LSZH	VOL-IO A524
48 fibre Loose Tube, gel filled w/ FRP LSZH	VOL-IO A548
72 fibre Loose Tube, gel filled w/ FRP LSZH	VOL-IO A572
96 fibre Loose Tube, gel filled w/ FRP LSZH	VOL-IO A596
<i>Backbone Indoor / Outdoor Cable, Aramid, 62.5/125µm multimode</i>	
2 fibre Unitube, gel filled w/ aramid yarn LSZH	VOL-IO A62
4 fibre Unitube, gel filled w/ aramid yarn LSZH	VOL-IO A64
6 fibre Unitube, gel filled w/ aramid yarn LSZH	VOL-IO A66
8 fibre Unitube, gel filled w/ aramid yarn LSZH	VOL-IO A68
12 fibre Unitube, gel filled w/ aramid yarn LSZH	VOL-IO A612
24 fibre Unitube, gel filled w/ aramid yarn LSZH	VOL-IO A624
48 fibre Loose Tube, gel filled w/ FRP LSZH	VOL-IO A648
72 fibre Loose Tube, gel filled w/ FRP LSZH	VOL-IO A672
96 fibre Loose Tube, gel filled w/ FRP LSZH	VOL-IO A696
<i>Backbone Indoor / Outdoor Cable, Aramid, 9/125µm singlemode</i>	
2 fibre Unitube, gel filled w/ aramid yarn LSZH	VOL-IO A924
4 fibre Unitube, gel filled w/ aramid yarn LSZH	VOL-IO A94
6 fibre Unitube, gel filled w/ aramid yarn LSZH	VOL-IO A96
8 fibre Unitube, gel filled w/ aramid yarn LSZH	VOL-IO A98
12 fibre Unitube, gel filled w/ aramid yarn LSZH	VOL-IO A912
24 fibre Unitube, gel filled w/ aramid yarn LSZH	VOL-IO A924
48 fibre Loose Tube, gel filled w/ FRP LSZH	VOL-IO A948
72 fibre Loose Tube, gel filled w/ FRP LSZH	VOL-IO A972
96 fibre Loose Tube, gel filled w/ FRP LSZH	VOL-IO A996
<i>Backbone Indoor / Outdoor Cable, glasyarn, 50/125µm multimode</i>	
2 fibre Unitube, gel filled w/ glasyarn LSZH	VOL-IO G52
4 fibre Unitube, gel filled w/ glasyarn LSZH	VOL-IO G54
6 fibre Unitube, gel filled w/ glasyarn LSZH	VOL-IO G56
8 fibre Unitube, gel filled w/ glasyarn LSZH	VOL-IO G58
12 fibre Unitube, gel filled w/ glasyarn LSZH	VOL-IO G512
24 fibre Unitube, gel filled w/ glasyarn LSZH	VOL-IO G524
48 fibre Loose Tube, gel filled w/ glasyarn w/ FRP LSZH	VOL-IO G548
72 fibre Loose Tube, gel filled w/ glasyarn w/ FRP LSZH	VOL-IO G572
96 fibre Loose Tube, gel filled w/ glasyarn w/ FRP LSZH	VOL-IO G596
<i>Backbone Indoor / Outdoor Cable, glasyarn, 62.5/125µm multimode</i>	
2 fibre Unitube, gel filled w/ glasyarn LSZH	VOL-IO G62
4 fibre Unitube, gel filled w/ glasyarn LSZH	VOL-IO G64
6 fibre Unitube, gel filled w/ glasyarn LSZH	VOL-IO G66
8 fibre Unitube, gel filled w/ glasyarn LSZH	VOL-IO G68
12 fibre Unitube, gel filled w/ glasyarn LSZH	VOL-IO G612
24 fibre Unitube, gel filled w/ glasyarn LSZH	VOL-IO G624
48 fibre Loose Tube, gel filled w/ glasyarn w/ FRP LSZH	VOL-IO G648
72 fibre Loose Tube, gel filled w/ glasyarn w/ FRP LSZH	VOL-IO G672
96 fibre Loose Tube, gel filled w/ glasyarn w/ FRP LSZH	VOL-IO G696

Fibre Components

Description	Ref.-No
<i>Backbone Indoor / Outdoor Cable, glasyarn, 9/125µm singlemode</i>	
2 fibre Unitube, gel filled w/ glasyarn LSZH	VOL-IO G92
4 fibre Unitube, gel filled w/ glasyarn LSZH	VOL-IO G94
6 fibre Unitube, gel filled w/ glasyarn LSZH	VOL-IO G96
8 fibre Unitube, gel filled w/ glasyarn LSZH	VOL-IO G98
12 fibre Unitube, gel filled w/ glasyarn LSZH	VOL-IO G912
24 fibre Unitube, gel filled w/ glasyarn LSZH	VOL-IO G924
48 fibre Loose Tube, gel filled w/ glasyarn w/ FRP LSZH	VOL-IO G948
72 fibre Loose Tube, gel filled w/ glasyarn w/ FRP LSZH	VOL-IO G972
96 fibre Loose Tube, gel filled w/ glasyarn w/ FRP LSZH	VOL-IO G996
<i>Backbone Indoor / Outdoor Cable, corrugated Steel, 50/125µm multimode</i>	
2 fibre Unitube, gel filled w/ aramid yarn & corrugated steel LSZH	VOL-IO S52
4 fibre Unitube, gel filled w/ aramid yarn & corrugated steel LSZH	VOL-IO S54
6 fibre Unitube, gel filled w/ aramid yarn & corrugated steel LSZH	VOL-IO S56
8 fibre Unitube, gel filled w/ aramid yarn & corrugated steel LSZH	VOL-IO S58
12 fibre Unitube, gel filled w/ aramid yarn & corrugated steel LSZH	VOL-IO S512
24 fibre Unitube, gel filled w/ aramid yarn & corrugated steel LSZH	VOL-IO S524
48 fibre Loose Tube, gel filled w/ FRP & corrugated steel LSZH	VOL-IO S548
72 fibre Loose Tube, gel filled w/ FRP & corrugated steel LSZH	VOL-IO S572
96 fibre Loose Tube, gel filled w/ FRP & corrugated steel LSZH	VOL-IO S596
<i>Backbone Indoor / Outdoor Cable, corrugated Steel, 62.5/125µm multimode</i>	
2 fibre Unitube, gel filled w/ aramid yarn & corrugated steel LSZH	VOL-IO S62
4 fibre Unitube, gel filled w/ aramid yarn & corrugated steel LSZH	VOL-IO S64
6 fibre Unitube, gel filled w/ aramid yarn & corrugated steel LSZH	VOL-IO S66
8 fibre Unitube, gel filled w/ aramid yarn & corrugated steel LSZH	VOL-IO S68
12 fibre Unitube, gel filled w/ aramid yarn & corrugated steel LSZH	VOL-IO S612
24 fibre Unitube, gel filled w/ aramid yarn & corrugated steel LSZH	VOL-IO S624
48 fibre Loose Tube, gel filled w/ FRP & corrugated steel LSZH	VOL-IO S648
72 fibre Loose Tube, gel filled w/ FRP & corrugated steel LSZH	VOL-IO S672
96 fibre Loose Tube, gel filled w/ FRP & corrugated steel LSZH	VOL-IO S696
<i>Backbone Indoor / Outdoor Cable, corrugated Steel, 9/125µm singlemode</i>	
2 fibre Unitube, gel filled w/ aramid yarn & corrugated steel LSZH	VOL-IO S92
4 fibre Unitube, gel filled w/ aramid yarn & corrugated steel LSZH	VOL-IO S94
6 fibre Unitube, gel filled w/ aramid yarn & corrugated steel LSZH	VOL-IO S96
8 fibre Unitube, gel filled w/ aramid yarn & corrugated steel LSZH	VOL-IO S98
12 fibre Unitube, gel filled w/ aramid yarn & corrugated steel LSZH	VOL-IO S912
24 fibre Unitube, gel filled w/ aramid yarn & corrugated steel LSZH	VOL-IO S924
48 fibre Loose Tube, gel filled w/ FRP & corrugated steel LSZH	VOL-IO S948
72 fibre Loose Tube, gel filled w/ FRP & corrugated steel LSZH	VOL-IO S972
96 fibre Loose Tube, gel filled w/ FRP & corrugated steel LSZH	VOL-IO S996

Fibre Components

Description	Ref.-No
FPC - Fibre Patch Cord	
Fibre Patch Cord, duplex VF-45™ to VF-45™, 50/125µm multimode, LSZH	VOL-V5L1
Patchcord, VF-45 to VF-45, 50µm, LSZH, 1m	VOL-V5L2
Patchcord, VF-45 to VF-45, 50µm, LSZH, 2m	VOL-V5L3
Patchcord, VF-45 to VF-45, 50µm, LSZH, 3m	VOL-V5L5
Patchcord, VF-45 to VF-45, 50µm, LSZH, 5m	
	
Fibre Patch Cord, duplex VF-45™ to ST, 50/125µm multimode, LSZH	VOL-T5L1
Patchcord, VF-45 to ST, 50µm, LSZH, 1m	VOL-T5L2
Patchcord, VF-45 to ST, 50µm, LSZH, 2m	VOL-T5L3
Patchcord, VF-45 to ST, 50µm, LSZH, 3m	VOL-T5L5
Patchcord, VF-45 to ST, 50µm, LSZH, 5m	
Fibre Patch Cord, duplex VF-45™ to SC, 50/125µm multimode, LSZH	VOL-C5L1
Patchcord, VF-45 to SC, 50µm, LSZH, 1m	VOL-C5L2
Patchcord, VF-45 to SC, 50µm, LSZH, 2m	VOL-C5L3
Patchcord, VF-45 to SC, 50µm, LSZH, 3m	VOL-C5L5
Patchcord, VF-45 to SC, 50µm, LSZH, 5m	
Fibre Patch Cord, duplex VF-45™ to LC, 50/125µm multimode, LSZH	VOL-L5L1
Patchcord, VF-45 to LC, 50µm, LSZH, 1m	VOL-L5L2
Patchcord, VF-45 to LC, 50µm, LSZH, 2m	VOL-L5L3
Patchcord, VF-45 to LC, 50µm, LSZH, 3m	VOL-L5L5
Patchcord, VF-45 to LC, 50µm, LSZH, 5m	
Fibre Patch Cord, duplex VF-45™ to MT-RJ, 50/125µm multimode, LSZH	VOL-M5RL1
Patchcord, VF-45 to MT-RJ, 50µm, LSZH, 1m	VOL-M5RL2
Patchcord, VF-45 to MT-RJ, 50µm, LSZH, 2m	VOL-M5RL3
Patchcord, VF-45 to MT-RJ, 50µm, LSZH, 3m	VOL-M5RL5
Patchcord, VF-45 to MT-RJ, 50µm, LSZH, 5m	
Fibre Patch Cord, duplex VF-45™ to VF-45™, 62.5/125µm multimode, LSZH	VOL-V6L1
Patchcord, VF-45 to VF-45, 62.5µm, LSZH, 1m	VOL-V6L2
Patchcord, VF-45 to VF-45, 62.5µm, LSZH, 2m	VOL-V6L3
Patchcord, VF-45 to VF-45, 62.5µm, LSZH, 3m	VOL-V6L5
Patchcord, VF-45 to VF-45, 62.5µm, LSZH, 5m	
Fibre Patch Cord, duplex VF-45™ to ST, 62.5/125µm multimode, LSZH	VOL-T6L1
Patchcord, VF-45 to ST, 62.5µm, LSZH, 1m	VOL-T6L2
Patchcord, VF-45 to ST, 62.5µm, LSZH, 2m	VOL-T6L3
Patchcord, VF-45 to ST, 62.5µm, LSZH, 3m	VOL-T6L5
Patchcord, VF-45 to ST, 62.5µm, LSZH, 5m	
Fibre Patch Cord, duplex VF-45™ to MT-RJ, 62.5/125µm multimode, LSZH	VOL-M6R/L1
Patchcord, VF-45 to MT-RJ, 62.5µm, LSZH, 1m	VOL-M6R/L2
Patchcord, VF-45 to MT-RJ, 62.5µm, LSZH, 2m	VOL-M6R/L3
Patchcord, VF-45 to MT-RJ, 62.5µm, LSZH, 3m	VOL-M6R/L5
Patchcord, VF-45 to MT-RJ, 62.5µm, LSZH, 5m	

Fibre Components

Description	Ref.-No
Fibre Patch Cord, duplex VF-45™ to SC, 62.5/125µm multimode, LSZH	VOL-C6L1
Patchcord, VF-45 to SC, 62.5µm, LSZH, 1m	VOL-C6L2
Patchcord, VF-45 to SC, 62.5µm, LSZH, 2m	VOL-C6L3
Patchcord, VF-45 to SC, 62.5µm, LSZH, 3m	VOL-C6L5
Patchcord, VF-45 to SC, 62.5µm, LSZH, 5m	
Fibre Patch Cord, duplex VF-45™ to LC, 62.5/125µm multimode, LSZH	VOL-L6L1
Patchcord, VF-45 to LC, 62.5µm, LSZH, 1m	VOL-L6L2
Patchcord, VF-45 to LC, 62.5µm, LSZH, 2m	VOL-L6L3
Patchcord, VF-45 to LC, 62.5µm, LSZH, 3m	VOL-L6L5
Patchcord, VF-45 to LC, 62.5µm, LSZH, 5m	
Fibre Patch Cord, duplex VF-45™ to VF-45™, 9/125µm singlemode, LSZH	VOL-V9L1
Patchcord, VF-45 to VF-45, SM LSZH, 1m	VOL-V9L2
Patchcord, VF-45 to VF-45, SM LSZH, 2m	VOL-V9L3
Patchcord, VF-45 to VF-45, SM LSZH, 3m	VOL-V9L5
Patchcord, VF-45 to VF-45, SM LSZH, 5m	
Fibre Patch Cord, duplex VF-45™ to ST, 9/125µm singlemode, LSZH	VOL-T9L1
Patchcord, VF-45 to ST, SM LSZH, 1m	VOL-T9L2
Patchcord, VF-45 to ST, SM LSZH, 2m	VOL-T9L3
Patchcord, VF-45 to ST, SM LSZH, 3m	VOL-T9L5
Patchcord, VF-45 to ST, SM LSZH, 5m	
Fibre Patch Cord, duplex VF-45™ to SC, 9/125µm singlemode, LSZH	VOL-C9L1
Patchcord, VF-45 to SC, SM LSZH, 1m	VOL-C9L2
Patchcord, VF-45 to SC, SM LSZH, 2m	VOL-C9L3
Patchcord, VF-45 to SC, SM LSZH, 3m	VOL-C9L5
Patchcord, VF-45 to SC, SM LSZH, 5m	
Fibre Patch Cord, duplex VF-45™ to MT-RJ, 9/125µm singlemode, LSZH	VOL-M9L1
Patchcord, VF-45 to MT-RJ, SM LSZH, 1m	VOL-M9L2
Patchcord, VF-45 to MT-RJ, SM LSZH, 2m	VOL-M9L3
Patchcord, VF-45 to MT-RJ, SM LSZH, 3m	VOL-M9L5
Patchcord, VF-45 to MT-RJ, SM LSZH, 5m	



Fibre Components

Description	Ref.-No
<p>Fibre Patch Cord duplex ST - ST 50/125µm multimode</p>	BANAN-AX0001
ST-ST patchcord duplex multimode 50/125µm, 1m	BANAN-AX0002
ST-ST patchcord duplex multimode 50/125µm, 2m	BANAN-AX0005
ST-ST patchcord duplex multimode 50/125µm, 5m	
<p>Fibre Patch Cord duplex ST - ST 62.5/125µm multimode</p>	BANAN-AQ0001
ST-ST patchcord duplex multimode 62.5/125µm, grey, 1m	BANAN-AQ0002
ST-ST patchcord duplex multimode 62.5/125µm, grey, 2m	BANAN-AQ0005
ST-ST patchcord duplex multimode 62.5/125µm, grey, 5m	
<p>Fibre Patch Cord duplex SC - SC 50/125µm multimode</p>	BDBDB-AX0001
SC-SC Patchcord duplex multimode 50/125µm, 1m	BDBDB-AX0002
SC-SC Patchcord duplex multimode 50/125µm, 2m	BDBDB-AX0005
SC-SC Patchcord duplex multimode 50/125µm, 5m	
<p>Fibre Patch Cords duplex SC - SC 62.5/125µm multimode</p>	BDBDB-AQ0001
SC-SC Patchcord duplex multimode 62.5/125µm, grey, 1m	BDBDB-AQ0002
SC-SC Patchcord duplex multimode 62.5/125µm, grey, 2m	BDBDB-AQ0005
SC-SC Patchcord duplex multimode 62.5/125µm, grey, 5m	
<p>Fibre Patch Cord duplex ST - SC 50/125µm multimode</p>	BANDB-AX0001
ST-SC Patchcord duplex multimode 50/125µm, grey, 1m	BANDB-AX0002
ST-SC Patchcord duplex multimode 50/125µm, grey, 2m	BANDB-AX0005
ST-SC Patchcord duplex multimode 50/125µm, grey, 5m	
<p>Fibre Patch Cord duplex ST - SC 62.5/125µm multimode</p>	BANDB-AQ0001
ST-SC Patchcord duplex multimode 62.5/125µm, 1m	BANDB-AQ0002
ST-SC Patchcord duplex multimode 62.5/125µm, 2m	BANDB-AQ0005
ST-SC Patchcord duplex multimode 62.5/125µm, 5m	
<p>Fibre Patch Cord duplex MTRJ - ST 50/125µm multimode</p>	BMTAN-AX0001
MTRJ-ST Patchcord duplex multimode 50/125µm, 1m	BMTAN-AX0002
MTRJ-ST Patchcord duplex multimode 50/125µm, 2m	BMTAN-AX0005
MTRJ-ST Patchcord duplex multimode 50/125µm, 5m	
<p>Fibre Patch Cord duplex MTRJ - SC 50/125µm multimode</p>	BMTDB-AX0001
MTRJ-SC Patchcord duplex multimode 50/125µm, 1m	BMTDB-AX0002
MTRJ-SC Patchcord duplex multimode 50/125µm, 2m	BMTDB-AX0005
MTRJ-SC Patchcord duplex multimode 50/125µm, 5m	



Copper Components

Description	Ref.-No
CJ - Copper Jacks	
<i>Volition™ RJ45 K6 Jacks</i>	
<p>Volition™ RJ45 K6 Jack, Cat 6, UTP, white</p> <p>Volition™ RJ45 K6 Jack, Cat 6, UTP, blue</p> <p>Volition™ RJ45 K6 Jack, Cat 6, UTP, green</p> <p>Volition™ RJ45 K6 Jack, Cat 6, UTP, red</p> <p>Volition™ RJ45 K6 Jack, Cat 6, UTP, yellow</p> <p>Volition™ RJ45 K6 Jack, Cat 6, UTP, black</p> <p>Volition™ RJ45 K6 Jack, Cat 6, UTP, orange</p> <p>Volition™ RJ45 K6 Jack, Cat 6, UTP, almond</p> <p>Volition™ RJ45 K6 Jack, Cat 6, FTP, white</p> <p>Volition™ RJ45 K6 Jack, Cat 6, STP, white and metallic shield</p>	 <p>VOL-OCK6-U</p> <p>VOL-OCK6-U-BL</p> <p>VOL-OCK6-U-G</p> <p>VOL-OCK6-U-R</p> <p>VOL-OCK6-U-Y</p> <p>VOL-OCK6-U-BK</p> <p>VOL-OCK6-U-O</p> <p>VOL-OCK6-U-AL</p> <p>VOL-OCK6-F</p> <p>VOL-OCK6-S</p>
<i>Volition™ RJ45 K5e Jacks</i>	
<p>Volition™ RJ45 K5e Jack, Cat 5e, UTP, white</p> <p>Volition™ RJ45 K5e Jack, Cat 5e, FTP, white</p> <p>Volition™ RJ45 K5e Jack, Cat 5e, STP, white and metallic shield</p>	 <p>VOL-OCK5E-U</p> <p>VOL-OCK5E-F</p> <p>VOL-OCK5E-S</p>
<i>Volition™ RJ45 Jacks, Giga</i>	
<p>Volition™ RJ45 Giga Jack, Cat 5e, UTP, light grey</p> <p>Volition™ RJ45 Giga Jack, Cat 5e, FTP, light grey</p> <p>Volition™ RJ45 Giga Jack, Cat 5e, STP, light grey and metallic shield</p>	 <p>P28770AB</p> <p>P28771AB</p> <p>P28772AB</p>
CS - Copper Sockets	
<i>Volition™ RJ45 Sockets, Giga</i>	
<i>Angled Front Face 30° downward</i>	
<p>Volition™ RJ45 Giga Jack, 8 pin, 22.5 x 45mm, Cat 5e, UTP</p> <p>Volition™ RJ45 Giga Jack, 9 pin, 22.5 x 45mm, Cat 5e, FTP</p> <p>Volition™ RJ45 Giga Jack, 22.5 x 45mm, Cat 5e, STP</p>	 <p>P28750AB</p> <p>P28751AB</p> <p>P28752AB</p>
<i>Vertical Front Face</i>	
<p>Volition™ RJ45 Giga Jack, 8 pin, 22.5 x 45mm, Cat 5e, UTP</p> <p>Volition™ RJ45 Giga Jack, 8 pin, 45 x 45mm, Cat 5e, UTP</p> <p>Volition™ RJ45 Giga Jack, 8 pin, 25 x 50mm, Cat 5e, UTP</p> <p>Volition™ RJ45 Giga Jack, 8 pin, 50 x 50mm, Cat 5e, UTP</p> <p>Volition™ RJ45 Giga Jack, 9 pin, 22.5 x 45mm, Cat 5e, FTP</p> <p>Volition™ RJ45 Giga Jack, 9 pin, 45 x 45mm, Cat 5e, FTP</p> <p>Volition™ RJ45 Giga Jack, 9 pin, 25 x 50mm, Cat 5e, FTP</p> <p>Volition™ RJ45 Giga Jack, 9 pin, 50 x 50mm, Cat 5e, FTP</p> <p>Volition™ RJ45 Giga Jack, 22.5 x 45mm, Cat 5e, STP</p> <p>Volition™ RJ45 Giga Jack, 45 x 45mm, Cat 5e, STP</p> <p>Volition™ RJ45 Giga Jack, 25 x 50mm, Cat 5e, STP</p> <p>Volition™ RJ45 Giga Jack, 50 x 50mm, Cat 5e, STP</p>	 <p>P28753AB</p> <p>P28756AB</p> <p>P28759AB</p> <p>P28762AB</p> <p>P28754AB</p> <p>P28757AB</p> <p>P28760AB</p> <p>P28763AB</p> <p>P28755AB</p> <p>P28758AB</p> <p>P28761AB</p> <p>P28764AB</p>

Copper Components

Description	Ref.-No
<i>Volition™ RJ45 Sockets, Qmax</i>	
Volition™ Flush mounted Socket, 2 ports, Qmax III, RAL1013	60-516-07000
Volition™ Flush mounted Socket, 2 ports, Qmax III, RAL9010	60-516-07025
Volition™ Surface mounted Socket, 2 ports, Qmax III, RAL1013	60-016-07000
Volition™ Surface mounted Socket, 2 ports, Qmax III, RAL9010	60-016-07025
Volition™ Flush mounted Single Shielded Socket, 2 ports, Qmax III, RAL1013	60-516-08000
Volition™ Flush mounted Single Shielded Socket, 2 ports, Qmax III, RAL9010	60-516-08025
Volition™ Surface mounted Single Shielded Socket, 2 ports, Qmax III, RAL1013	60-016-08000
Volition™ Surface mounted Single Shielded Socket, 2 ports, Qmax III, RAL9010	60-016-08025

Volition™ RJ45 Sockets, Keystone

Flush mounted

Volition™ Flush mounted Socket equipped with 2 x RJ45 K6 Jacks, central fixing, keystone, beige	VOL-SGFCB-W2K
Volition™ Flush mounted Socket equipped with 2 x RJ45 K6 Jacks, central fixing, keystone, white	VOL-SGFCW-W2K
Volition™ Flush mounted Socket equipped with 2 x RJ45 K6 Jacks, keystone, beige	VOL-SGFB-W2K
Volition™ Flush mounted Socket equipped with 2 x RJ45 K6 Jacks, keystone, white	VOL-SGFW-W2K
Volition™ Flush mounted Socket equipped with 1 x RJ45 K6 Jack, central fixing, keystone, beige	VOL-SGFCB-W1K
Volition™ Flush mounted Socket equipped with 1 x RJ45 K6 Jack, central fixing, keystone, white	VOL-SGFCW-W1K
Volition™ Flush mounted Socket equipped with 1 x RJ45 K6 Jacks, keystone, beige	VOL-SGFB-W1K
Volition™ Flush mounted Socket equipped with 1 x RJ45 K6 Jacks, keystone, white	VOL-SGFW-W1K

Surface mounted

Volition™ Surface mounted Socket equipped with 2 x RJ45 K6 Jacks, keystone, beige	VOL-SGSB-W2K
Volition™ Surface mounted Socket equipped with 2 x RJ45 K6 Jacks, keystone, white	VOL-SGSW-W2K
Volition™ Surface mounted Socket equipped with 1 x RJ45 K6 Jack, keystone, beige	VOL-SGSB-W1K
Volition™ Surface mounted Socket equipped with 1 x RJ45 K6 Jack, keystone, white	VOL-SGSW-W1K

CM - Copper modules

Quante™ SID™-C Modules

SID-C Disconnection Module 10 pairs	79103-534 00
SID-CD Disconnection Module for 10 pairs	79103-538 00
SID-C Disconnection Module 8 pairs	79103-540 00
SID-CD Disconnection Module for 8 pairs	79103-541 00
SID-C Connection Module for 8 pair	79101-561 00
SID-C Connection Module for 10 pair	79101-553 00
SID-CT Connection Module for 8 pair	79101-588 00
SID-CT Connection Module for 10 pair	79101-589 00
SID-CT Disconnection Module for 8 pair	79103-564 00
SID-CT Disconnection Module for 10 pair	79103-557 00

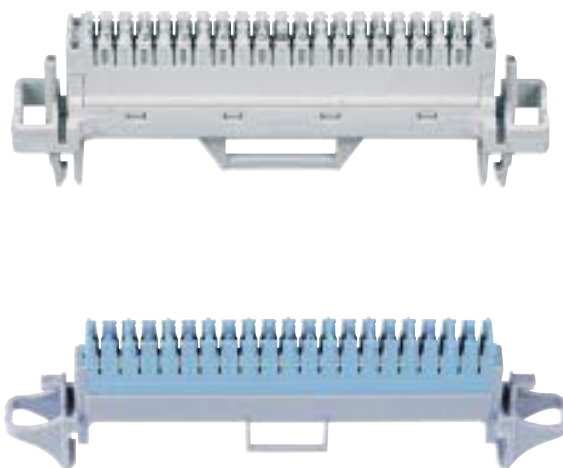

Quante™ STG 2000 Modules

STG2 C2 8 Disconnection Module marked from 1 to 8 on jumper side, white	C252800A
STG2 C2 10 Disconnection Module marked from 1 to 10 on jumper side, white	C252818A
STG2 U2 8 Con. Mod. from 1 to 8 on jump side, light grey w mutlipair prot. facility	C252807A
STG2 U2 10 Con. Mod. from 1 to 10 on jump side, light grey w mutlipair prot. facility	C252825A
STG2 C2 8 Disc. Mod. from 1 to 8 on jump side, light grey w mutlipair prot. facility	C252801A
STG2 C2 10 Disc. Mod. from 1 to 10 on jump side, light grey w mutlipair prot. facility	C252819A
STG2 C2 8 Disc. Mod. from 1 to 8 on jump side, light grey w singlepair prot. facility	C252802A
STG2 C2 10 Disc. Mod. from 1 to 10 on jump side, light grey w singlepair prot. facility	C252820A

Copper Components

Description	Ref.-No
Quante™ RCP Modules	
<i>Unshielded</i>	
RCP unshielded 8 pr disconnection blue	P45920DA
RCP unshielded 8 pr disconnection yellow	P45840DA
RCP unshielded 8 pr disconnection green	P45839DA
RCP unshielded 8 pr disconnection red	P45809DA
RCP unshielded 8 pr disconnection ivory	P45734DA
RCP unshielded side entry 8 pr disconnection blue	P45920CE
RCP unshielded side entry 8 pr disconnection yellow	P45840CE
RCP unshielded side entry 8 pr disconnection green	P45839CE
RCP unshielded side entry 8 pr disconnection red	P45809CE
RCP unshielded side entry 8 pr disconnection ivory	P45734CE
<i>Shielded</i>	
RCP shielded 8 pr disconnection blue	P45920DH
RCP shielded 8 pr disconnection yellow	P45840DH
RCP shielded 8 pr disconnection green	P45839DH
RCP shielded 8 pr disconnection red	P45809DH
RCP shielded 8 pr disconnection ivory	P45734DH

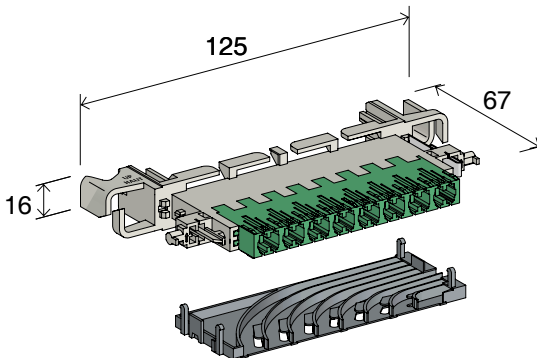

CFP - Copper Face Plates

Volition™ RJ45 Faceplates, Keystone

Volition™ Faceplates, keystone

Volition™ 22.5 x 45 Faceplate, 1 port, keystone, white

VOL-FP2M-F1K

Volition™ 45 x 45 Faceplate, 1 port, keystone, white

VOL-FP4M-F1K

Volition™ 45 x 45 Faceplate, 2 ports, keystone, white

VOL-FP4M-F2K

Volition™ Single Gang Faceplates, keystone

Volition™ Single Gang Faceplate, 2 ports, keystone, bright white

VOL-0712B

Volition™ Single Gang Faceplate, 2 ports, keystone, office white

VOL-0712

Volition™ Single Gang Faceplate, 4 ports, keystone, office white

VOL-0714

Volition™ Single Gang Faceplate, 4 ports, keystone, bright white

VOL-0714B

Volition™ U.K. Single Gang Faceplates, keystone

Volition™ U.K. Single Gang Faceplate, 1 port, keystone, white

VOL-FPUK-1K

Volition™ U.K. Single Gang Faceplate, 2 ports, keystone, white

VOL-FPUK-2K

Volition™ German Faceplates, keystone

Volition™ German Flush mounted Faceplate, 2 ports, keystone, beige

VOL-SGFB-F2K

Volition™ German Flush mounted Faceplate, 2 ports, keystone, white

VOL-SGFW-F2K

Volition™ German Surface mounted Faceplate, 2 ports, keystone, beige

VOL-SGSB-F2K

Volition™ German Surface mounted Faceplate, 2 ports, keystone, white

VOL-SGSW-F2K

Volition™ RJ45 Faceplates, Giga

Volition™ German Faceplates, Giga

Volition™ German Flush mounted 50 x 50 Faceplate, 2 ports, Giga, RAL1013

60-516-04000

Volition™ German Flush mounted 50 x 50 Faceplate, 2 ports, Giga, RAL9010

60-516-04025

Volition™ German Surface mounted 50 x 50 Faceplate, 2 ports, Giga, RAL1013

60-016-04000

Volition™ German Surface mounted 50 x 50 Faceplate, 2 ports, Giga, RAL9010

60-016-04025

Volition™ American Faceplate, Giga

Volition™ American Faceplate for 2 x RJ45 Giga Jacks

VOL-F5V2R1COW



Copper Components

Description	Ref.-No
CPP - Copper Patch Panels	
<i>Volition™ RJ45 K Patch Panels</i>	
<i>Classic Serie</i>	
Volition™ Classic Patch Panel, 16 ports, keystone, brushed alu	VOL-PPCA-F16K
Volition™ Classic Patch Panel, 24 ports, keystone, brushed alu	VOL-PPCA-F24K
Volition™ Classic Patch Panel, 32 ports, keystone, brushed alu	VOL-PPCA-F32K
Volition™ Classic Patch Panel, 48 ports, keystone, brushed alu	VOL-PPCA-F48K
Volition™ Classic Patch Panel, 16 ports, keystone, black alu	VOL-PPCB-F16K
Volition™ Classic Patch Panel, 24 ports, keystone, black alu	VOL-PPCB-F24K
Volition™ Classic Patch Panel, 32 ports, keystone, black alu	VOL-PPCB-F32K
Volition™ Classic Patch Panel, 48 ports, keystone, black alu	VOL-PPCB-F48K
<i>Economic Serie</i>	
Volition™ Economic Patch Panel, double plate, 16 ports, UTP, keystone, black alu	VOL-PPUD-F16K
Volition™ Economic Patch Panel, double plate, 24 ports, UTP, keystone, black alu	VOL-PPUD-F24K
<i>German Serie</i>	
Volition™ German Patch Panel, 16 ports, keystone, brushed alu	VOL -PPGA-W16K
Volition™ German Patch Panel, 24 ports, keystone, brushed alu	VOL-PPGA-W24K
Volition™ German Patch Panel, with cover, 16 ports, keystone, brushed alu	VOL-PGCA-W16K
Volition™ German Patch Panel, with cover, 24 ports, keystone, brushed alu	VOL-PGCA-W24K
<i>Volition™ RJ45 Patch Panels Giga and Qmax</i>	
<i>Giga Serie</i>	
Volition™ 19" x 1U x 70mm Patch Panel, 16 ports, Giga, brushed alu	P33255AA
Volition™ 19" x 1U x 70mm Patch Panel, 16 ports, Giga, black alu	P33355AA
Volition™ 19" x 1U x 100mm Patch Panel, 24 ports, Giga, brushed alu	P33275AA
Volition™ 19" x 1U x 100mm Patch Panel, 24 ports, Giga, black alu	P33375AA
Volition™ 19" x 2U x 100mm Patch Panel, 32 ports, Giga, brushed alu	P33265AA
Volition™ 19" x 2U x 100 mm Patch Panel, 32 ports, Giga, black alu	P33365AA
Volition™ 19" x 2U x 130mm Patch Panel, 48 ports, Giga, brushed alu	P33285AA
Volition™ 19" x 2U x 130mm Patch Panel, 48 ports, Giga, black alu	P33385AA
Volition™ 19" x 1U Patch Panel, 16 ports, Giga, brushed alu	43018-653 30
Volition™ 19" x 1U Patch Panel, 24 ports, Giga, brushed alu	43018-654 30
<i>Qmax Serie</i>	
Volition™ Patch Panel, 16 ports, Qmax, single shield	43018-677 30
Volition™ Patch Panel, 24 ports, Qmax, single shield	43018-678 30
Volition™ Patch Panel, 16 ports, Qmax	43018-679 30
Volition™ Patch Panel, 24 ports, Qmax	43018-684 30
<i>Cat5e IDC Patch Panels</i>	
Volition™ 19" x 1U x 120mm IDC Patch Panel, 16 ports, UTP, beige	43018-630 30
Volition™ 19" x 1U x 120mm IDC Patch Panel, 24 ports, UTP, beige	43018-628 30
Volition™ 19" x 1U x 170mm IDC Patch Panel, 16 ports, Shielded, beige	43018-593 33
Volition™ 19" x 1U x 170mm IDC Patch Panel, 24 ports, Shielded, beige	43018-592 33
<i>Accessories For K6/K5e panels only</i>	
Volition™ Blanking Plug, keystone, black	0300BK
Volition™ Blanking Plug, keystone, white	0300
Volition™ Port Identification Bezel, keystone, Red	VOL-PCC-R
Volition™ Port Identification Bezel, keystone, Yellow	VOL-PCC-Y
Volition™ Port Identification Bezel, keystone, Green	VOL-PCC-G
Volition™ Port Identification Bezel, keystone, Blue	VOL-PCC-B

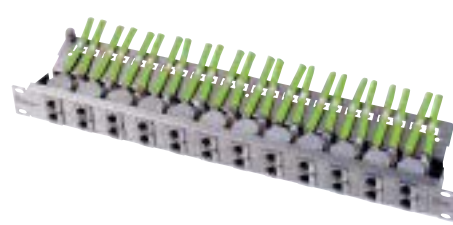

Copper Components

Description	Ref.-No
CHC - Copper Horizontal Cable	
<i>Volition™ Cat 5e Cable</i>	
<i>UTP Cables</i>	
Volition™ Cat 5e Cable, UTP, PVC, 4 pairs, 305m Box	VOL-5EUP4-305
Volition™ Cat 5e Cable, UTP, PVC, 4 pairs, 500m Drum	VOL-5EUP4-500
Volition™ Cat 5e Cable, UTP, PVC, 4 pairs, 1000m Drum	VOL-5EUP4-1000
Volition™ Cat 5e Cable, UTP, PVC, 2 x 4 pairs, 500m Drum	VOL-5EUP8-500
Volition™ Cat 5e Cable, UTP, PVC, 2 x 4 pairs, 1000m Drum	VOL-5EUP8-1000
Volition™ Cat 5e Cable, UTP, LSOH, 4 pairs, 305m Box	VOL-5EUL4-305
Volition™ Cat 5e Cable, UTP, LSOH, 4 pairs, 1000m Drum	VOL-5EUL4-1000
Volition™ Cat 5e Cable, UTP, LSOH, 2 x 4 pairs, 1000m Drum	VOL-5EUL8-1000
<i>FTP Cables</i>	
Volition™ Cat 5e Cable, FTP, PVC, 4 pairs, 305m Box	VOL-5EFP4-305
Volition™ Cat 5e Cable, FTP, PVC, 4 pairs, 1000m Drum	VOL-5EFP4-1000
Volition™ Cat 5e Cable, FTP, LSOH, 4 pairs, 305m Box	VOL-5EFL4-305
Volition™ Cat 5e Cable, FTP, LSOH, 4 pairs, 500m Drum	VOL-5EFL4-500
Volition™ Cat 5e Cable, FTP, LSOH, 4 pairs, 1000m Drum	VOL-5EFL4-1000
Volition™ Cat 5e Cable, FTP, LSOH, 2 x 4 pairs, 500m Drum	VOL-5EFL8-500
Volition™ Cat 5e Cable, FTP, LSOH, 2 x 4 pairs, 1000m Drum	VOL-5EFL8-1000
<i>Volition™ Cat 6 Cable</i>	
<i>UTP Cables</i>	
Volition™ Cat 6 Cable, UTP, PVC, 4 pairs, 305m Box	VOL-6UP4-305
Volition™ Cat 6 Cable, UTP, PVC, 4 pairs, 500m Drum	VOL-6UP4-500
Volition™ Cat 6 Cable, UTP, PVC, 4 pairs, 1000m Drum	VOL-6UP4-1000
Volition™ Cat 6 Cable, UTP, PVC, 2 x 4 pairs, 500m Drum	VOL-6UP8-500
Volition™ Cat 6 Cable, UTP, PVC, 2 x 4 pairs, 1000m Drum	VOL-6UP8-1000
Volition™ Cat 6 Cable, UTP, LSOH, 4 pairs, 305m Box	VOL-6UL4-305
Volition™ Cat 6 Cable, UTP, LSOH, 4 pairs, 500m Drum	VOL-6UL4-500
Volition™ Cat 6 Cable, UTP, LSOH, 4 pairs, 1000m Drum	VOL-6UL4-1000
Volition™ Cat 6 Cable, UTP, LSOH, 2 x 4 pairs, 500m Drum	VOL-6UL8-500
Volition™ Cat 6 Cable, UTP, LSOH, 2 x 4 pairs, 1000m Drum	VOL-6UL8-1000
<i>FTP Cables</i>	
Volition™ Cat 6 Cable, FTP, PVC, 4 pairs, 1000m Drum	VOL-6FP4-1000
Volition™ Cat 6 Cable, FTP, LSOH, 4 pairs, 500m Drum	VOL-6FL4-500
Volition™ Cat 6 Cable, FTP, LSOH, 4 pairs, 1000m Drum	VOL-6FL4-1000
Volition™ Cat 6 Cable, FTP, LSOH, 2 x 4 pairs, 500m Drum	VOL-6FL8-500
Volition™ Cat 6 Cable, FTP, LSOH, 2 x 4 pairs, 1000m Drum	VOL-6FL8-1000
<i>FFTP Cables</i>	
Volition™ Cat 6 Cable, FFTP, LSOH, 4 pairs, 500m Drum	VOL-6FFL4-500
Volition™ Cat 6 Cable, FFTP, LSOH, 4 pairs, 1000m Drum	VOL-6FFL4-1000
Volition™ Cat 6 Cable, FFTP, LSOH, 2 x 4 pairs, 500m Drum	VOL-6FFL8-500
Volition™ Cat 6 Cable, FFTP, LSOH, 2 x 4 pairs, 1000m Drum	VOL-6FFL8-1000
<i>Volition™ Cat 7 Cable</i>	
<i>SFTP Cables</i>	
Volition™ Cat 7 Cable, SFTP, LSOH, 4 pairs, 500m Drum	VOL-7SSL4-500
Volition™ Cat 7 Cable, SFTP, LSOH, 4 pairs, 1000m Drum	VOL-7SSL4-1000
Volition™ Cat 7 Cable, SFTP, LSOH, 2 x 4 pairs, 500m Drum	VOL-7SSL8-500
Volition™ Cat 7 Cable, SFTP, LSOH, 2 x 4 pairs, 1000m Drum	VOL-7SSL8-1000

Copper Components

Description	Ref.-No
CBBC - Copper Backbone Cable	
Vollition™ Cat 5 Backbone Cable, FTP, LSOH, 32 pairs, 1m	VOL-5EFL32-M
Vollition™ Cat 5 Backbone Cable, UTP, PVC, 25 pairs, 1m	VOL-5UP25-M
Vollition™ Cat 5 Backbone Cable, UTP, PVC, 50 pairs, 1m	VOL-5UP50-M
CPC - Copper Patch Cables	
<i>Vollition™ Cat 5e RJ45 to RJ45 Patch Cable</i>	
<i>UTP Patch Cables</i>	
Vollition™ Cat 5e RJ45 to RJ45 Patch Cable, UTP, PVC, 1m	VOL-5EUP-L1
Vollition™ Cat 5e RJ45 to RJ45 Patch Cable, UTP, PVC, 2m	VOL-5EUP-L2
Vollition™ Cat 5e RJ45 to RJ45 Patch Cable, UTP, PVC, 3m	VOL-5EUP-L3
Vollition™ Cat 5e RJ45 to RJ45 Patch Cable, UTP, PVC, 4m	VOL-5EUP-L4
Vollition™ Cat 5e RJ45 to RJ45 Patch Cable, UTP, PVC, 5m	VOL-5EUP-L5
Vollition™ Cat 5e RJ45 to RJ45 Patch Cable, UTP, LSOH, 1m	VOL-5EUL-L1
Vollition™ Cat 5e RJ45 to RJ45 Patch Cable, UTP, LSOH, 2m	VOL-5EUL-L2
Vollition™ Cat 5e RJ45 to RJ45 Patch Cable, UTP, LSOH, 3m	VOL-5EUL-L3
Vollition™ Cat 5e RJ45 to RJ45 Patch Cable, UTP, LSOH, 4m	VOL-5EUL-L4
Vollition™ Cat 5e RJ45 to RJ45 Patch Cable, UTP, LSOH, 5m	VOL-5EUL-L5
Vollition™ Cat 5e RJ45 to RJ45 Patch Cable, UTP, LSOH, 1m, red	VOL-5EUL-L1-R
Vollition™ Cat 5e RJ45 to RJ45 Patch Cable, UTP, LSOH, 2m, red	VOL-5EUL-L2-R
Vollition™ Cat 5e RJ45 to RJ45 Patch Cable, UTP, LSOH, 3m, red	VOL-5EUL-L3-R
Vollition™ Cat 5e RJ45 to RJ45 Patch Cable, UTP, LSOH, 5m, red	VOL-5EUL-L5-R
Vollition™ Cat 5e RJ45 to RJ45 Patch Cable, UTP, LSOH, 1m, yellow	VOL-5EUL-L1-Y
Vollition™ Cat 5e RJ45 to RJ45 Patch Cable, UTP, LSOH, 2m, yellow	VOL-5EUL-L2-Y
Vollition™ Cat 5e RJ45 to RJ45 Patch Cable, UTP, LSOH, 3m, yellow	VOL-5EUL-L3-Y
Vollition™ Cat 5e RJ45 to RJ45 Patch Cable, UTP, LSOH, 5m, yellow	VOL-5EUL-L5-Y
Vollition™ Cat 5e RJ45 to RJ45 Patch Cable, UTP, LSOH, 1m, green	VOL-5EUL-L1-GR
Vollition™ Cat 5e RJ45 to RJ45 Patch Cable, UTP, LSOH, 2m, green	VOL-5EUL-L2-GR
Vollition™ Cat 5e RJ45 to RJ45 Patch Cable, UTP, LSOH, 3m, green	VOL-5EUL-L3-GR
Vollition™ Cat 5e RJ45 to RJ45 Patch Cable, UTP, LSOH, 5m, green	VOL-5EUL-L5-GR
Vollition™ Cat 5e RJ45 to RJ45 Patch Cable, UTP, LSOH, 1m, blue	VOL-5EUL-L1-B
Vollition™ Cat 5e RJ45 to RJ45 Patch Cable, UTP, LSOH, 2m, blue	VOL-5EUL-L2-B
Vollition™ Cat 5e RJ45 to RJ45 Patch Cable, UTP, LSOH, 3m, blue	VOL-5EUL-L3-B
Vollition™ Cat 5e RJ45 to RJ45 Patch Cable, UTP, LSOH, 5m, blue	VOL-5EUL-L5-B
<i>FTP Patch Cables</i>	
Vollition™ Cat 5e RJ45 to RJ45 Patch Cable, FTP, LSOH, 1m	VOL-5EFL-L1
Vollition™ Cat 5e RJ45 to RJ45 Patch Cable, FTP, LSOH, 2m	VOL-5EFL-L2
Vollition™ Cat 5e RJ45 to RJ45 Patch Cable, FTP, LSOH, 3m	VOL-5EFL-L3
Vollition™ Cat 5e RJ45 to RJ45 Patch Cable, FTP, LSOH, 4m	VOL-5EFL-L4
Vollition™ Cat 5e RJ45 to RJ45 Patch Cable, FTP, LSOH, 5m	VOL-5EFL-L5
Vollition™ Cat 5e RJ45 to RJ45 Patch Cable, FTP, LSOH, 1m, red	VOL-5EFL-L1-R
Vollition™ Cat 5e RJ45 to RJ45 Patch Cable, FTP, LSOH, 2m, red	VOL-5EFL-L2-R
Vollition™ Cat 5e RJ45 to RJ45 Patch Cable, FTP, LSOH, 3m, red	VOL-5EFL-L3-R
Vollition™ Cat 5e RJ45 to RJ45 Patch Cable, FTP, LSOH, 5m, red	VOL-5EFL-L5-R
Vollition™ Cat 5e RJ45 to RJ45 Patch Cable, FTP, LSOH, 1m, yellow	VOL-5EFL-L1-Y
Vollition™ Cat 5e RJ45 to RJ45 Patch Cable, FTP, LSOH, 2m, yellow	VOL-5EFL-L2-Y
Vollition™ Cat 5e RJ45 to RJ45 Patch Cable, FTP, LSOH, 3m, yellow	VOL-5EFL-L3-Y

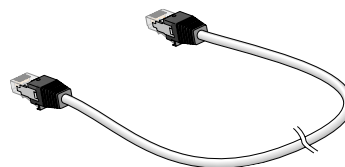

Copper Components

Description	Ref.-No
Volition™ Cat 5e RJ45 to RJ45 Patch Cable, FTP, LSOH, 5m, yellow	VOL-5EFL-L5-Y
Volition™ Cat 5e RJ45 to RJ45 Patch Cable, FTP, LSOH, 1m, green	VOL-5EFL-L1-GR
Volition™ Cat 5e RJ45 to RJ45 Patch Cable, FTP, LSOH, 2m, green	VOL-5EFL-L2-GR
Volition™ Cat 5e RJ45 to RJ45 Patch Cable, FTP, LSOH, 3m, green	VOL-5EFL-L3-GR
Volition™ Cat 5e RJ45 to RJ45 Patch Cable, FTP, LSOH, 5m, green	VOL-5EFL-L5-GR
Volition™ Cat 5e RJ45 to RJ45 Patch Cable, FTP, LSOH, 1m, blue	VOL-5EFL-L1-B
Volition™ Cat 5e RJ45 to RJ45 Patch Cable, FTP, LSOH, 2m, blue	VOL-5EFL-L2-B
Volition™ Cat 5e RJ45 to RJ45 Patch Cable, FTP, LSOH, 3m, blue	VOL-5EFL-L3-B
Volition™ Cat 5e RJ45 to RJ45 Patch Cable, FTP, LSOH, 5m, blue	VOL-5EFL-L5-B
<i>SFTP Patch Cables</i>	
Volition™ Cat 5e RJ45 to RJ45 Patch Cable, SFTP, LSOH, 1m	VOL-5ESFL-L1
Volition™ Cat 5e RJ45 to RJ45 Patch Cable, SFTP, LSOH, 2m	VOL-5ESFL-L2
Volition™ Cat 5e RJ45 to RJ45 Patch Cable, SFTP, LSOH, 3m	VOL-5ESFL-L3
Volition™ Cat 5e RJ45 to RJ45 Patch Cable, SFTP, LSOH, 4m	VOL-5ESFL-L4
Volition™ Cat 5e RJ45 to RJ45 Patch Cable, SFTP, LSOH, 5m	VOL-5ESFL-L5
Volition™ Cat 6 RJ45 to RJ45 Patch Cable	
<i>UTP Patch Cables</i>	
Volition™ Cat 6 RJ45 to RJ45 Patch Cable, UTP, LSOH, 1m	VOL-6UL-L1
Volition™ Cat 6 RJ45 to RJ45 Patch Cable, UTP, LSOH, 2m	VOL-6UL-L2
Volition™ Cat 6 RJ45 to RJ45 Patch Cable, UTP, LSOH, 3m	VOL-6UL-L3
Volition™ Cat 6 RJ45 to RJ45 Patch Cable, UTP, LSOH, 4m	VOL-6UL-L4
Volition™ Cat 6 RJ45 to RJ45 Patch Cable, UTP, LSOH, 5m	VOL-6UL-L5
Volition™ Cat 6 RJ45 to RJ45 Patch Cable, UTP, LSOH, 1m, red	VOL-6UL-L1-R
Volition™ Cat 6 RJ45 to RJ45 Patch Cable, UTP, LSOH, 2m, red	VOL-6UL-L2-R
Volition™ Cat 6 RJ45 to RJ45 Patch Cable, UTP, LSOH, 3m, red	VOL-6UL-L3-R
Volition™ Cat 6 RJ45 to RJ45 Patch Cable, UTP, LSOH, 5m, red	VOL-6UL-L5-R
Volition™ Cat 6 RJ45 to RJ45 Patch Cable, UTP, LSOH, 1m, yellow	VOL-6UL-L1-Y
Volition™ Cat 6 RJ45 to RJ45 Patch Cable, UTP, LSOH, 2m, yellow	VOL-6UL-L2-Y
Volition™ Cat 6 RJ45 to RJ45 Patch Cable, UTP, LSOH, 3m, yellow	VOL-6UL-L3-Y
Volition™ Cat 6 RJ45 to RJ45 Patch Cable, UTP, LSOH, 5m, yellow	VOL-6UL-L5-Y
Volition™ Cat 6 RJ45 to RJ45 Patch Cable, UTP, LSOH, 1m, green	VOL-6UL-L1-GR
Volition™ Cat 6 RJ45 to RJ45 Patch Cable, UTP, LSOH, 2m, green	VOL-6UL-L2-GR
Volition™ Cat 6 RJ45 to RJ45 Patch Cable, UTP, LSOH, 3m, green	VOL-6UL-L3-GR
Volition™ Cat 6 RJ45 to RJ45 Patch Cable, UTP, LSOH, 5m, green	VOL-6UL-L5-GR
Volition™ Cat 6 RJ45 to RJ45 Patch Cable, UTP, LSOH, 1m, blue	VOL-6UL-L1-B
Volition™ Cat 6 RJ45 to RJ45 Patch Cable, UTP, LSOH, 2m, blue	VOL-6UL-L2-B
Volition™ Cat 6 RJ45 to RJ45 Patch Cable, UTP, LSOH, 3m, blue	VOL-6UL-L3-B
Volition™ Cat 6 RJ45 to RJ45 Patch Cable, UTP, LSOH, 5m, blue	VOL-6UL-L5-B
<i>SSTP Patch Cables</i>	
Volition™ Cat 6 RJ45 to RJ45 Patch Cable, SSTP, LSOH, 1m	VOL-6SSL-L1
Volition™ Cat 6 RJ45 to RJ45 Patch Cable, SSTP, LSOH, 2m	VOL-6SSL-L2
Volition™ Cat 6 RJ45 to RJ45 Patch Cable, SSTP, LSOH, 3m	VOL-6SSL-L3
Volition™ Cat 6 RJ45 to RJ45 Patch Cable, SSTP, LSOH, 4m	VOL-6SSL-L4
Volition™ Cat 6 RJ45 to RJ45 Patch Cable, SSTP, LSOH, 5m	VOL-6SSL-L5
Volition™ Cat 6 RJ45 to RJ45 Patch Cable, SSTP, LSOH, 1m, red	VOL-6SSL-L1-R
Volition™ Cat 6 RJ45 to RJ45 Patch Cable, SSTP, LSOH, 2m, red	VOL-6SSL-L2-R
Volition™ Cat 6 RJ45 to RJ45 Patch Cable, SSTP, LSOH, 3m, red	VOL-6SSL-L3-R
Volition™ Cat 6 RJ45 to RJ45 Patch Cable, SSTP, LSOH, 5m, red	VOL-6SSL-L5-R
Volition™ Cat 6 RJ45 to RJ45 Patch Cable, SSTP, LSOH, 1m, yellow	VOL-6SSL-L1-Y

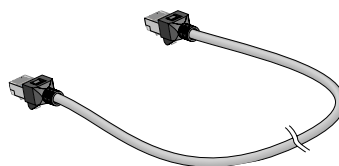

Copper Components

Description	Ref.-No
Vollition™ Cat 6 RJ45 to RJ45 Patch Cable, SSTP, LSOH, 2m, yellow	VOL-6SSL-L2-Y
Vollition™ Cat 6 RJ45 to RJ45 Patch Cable, SSTP, LSOH, 3m, yellow	VOL-6SSL-L3-Y
Vollition™ Cat 6 RJ45 to RJ45 Patch Cable, SSTP, LSOH, 5m, yellow	VOL-6SSL-L5-Y
Vollition™ Cat 6 RJ45 to RJ45 Patch Cable, SSTP, LSOH, 1m, green	VOL-6SSL-L1-GR
Vollition™ Cat 6 RJ45 to RJ45 Patch Cable, SSTP, LSOH, 2m, green	VOL-6SSL-L2-GR
Vollition™ Cat 6 RJ45 to RJ45 Patch Cable, SSTP, LSOH, 3m, green	VOL-6SSL-L3-GR
Vollition™ Cat 6 RJ45 to RJ45 Patch Cable, SSTP, LSOH, 5m, green	VOL-6SSL-L5-GR
Vollition™ Cat 6 RJ45 to RJ45 Patch Cable, SSTP, LSOH, 1m, blue	VOL-6SSL-L1-B
Vollition™ Cat 6 RJ45 to RJ45 Patch Cable, SSTP, LSOH, 2m, blue	VOL-6SSL-L2-B
Vollition™ Cat 6 RJ45 to RJ45 Patch Cable, SSTP, LSOH, 3m, blue	VOL-6SSL-L3-B
Vollition™ Cat 6 RJ45 to RJ45 Patch Cable, SSTP, LSOH, 5m, blue	VOL-6SSL-L5-B

CTC - Copper Telephone Cords

Quante™ CBE - CBE UTP Patch Cords

LSOH Sheath - 1 Pair

- Grey / green polycarbonate shell, UTP cable, Straight cabling, 0.5m
- Grey / green polycarbonate shell, UTP cable, Straight cabling, 1.0m
- Grey / green polycarbonate shell, UTP cable, Straight cabling, 2.0m
- Grey / green polycarbonate shell, UTP cable, Straight cabling, 3.0m
- Grey / green polycarbonate shell, UTP cable, Straight cabling, 4.0m
- Grey / green polycarbonate shell, UTP cable, Straight cabling, 5.0m

LSOH Sheath - 2 Pair

- Grey / green polycarbonate shell, UTP cable, Straight cabling, 0.5m
- Grey / green polycarbonate shell, UTP cable, Straight cabling, 1.0m
- Grey / green polycarbonate shell, UTP cable, Straight cabling, 2.0m
- Grey / green polycarbonate shell, UTP cable, Straight cabling, 3.0m
- Grey / green polycarbonate shell, UTP cable, Straight cabling, 4.0m
- Grey / green polycarbonate shell, UTP cable, Straight cabling, 5.0m

LSOH Sheath - 4 Pair

- Grey / green polycarbonate shell, UTP cable, Straight cabling, 0.5m
- Grey / green polycarbonate shell, UTP cable, Straight cabling, 1.0m
- Grey / green polycarbonate shell, UTP cable, Straight cabling, 2.0m
- Grey / green polycarbonate shell, UTP cable, Straight cabling, 3.0m
- Grey / green polycarbonate shell, UTP cable, Straight cabling, 4.0m
- Grey / green polycarbonate shell, UTP cable, Straight cabling, 5.0m

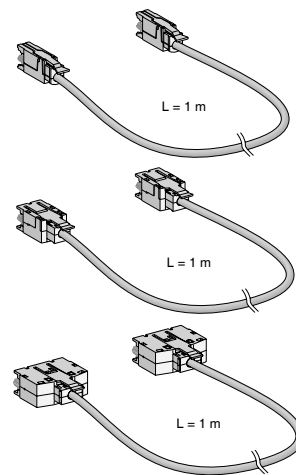

- P39421D5
- P39421A5
- P39431A5
- P39431J5
- P39431L5
- P39431M5

- P39412A5
- P39422A5
- P39432A5
- P39442A5
- P39442L5
- P39442M5

Quante™ CBE - CBE UTP Patch Cords

PVC Sheath - 1 Pair

- Grey / green polycarbonate shell, UTP cable, Straight cabling, 1.0m
- Grey / green polycarbonate shell, UTP cable, Straight cabling, 2.0m

PVC Sheath - 2 Pair

- Grey / green polycarbonate shell, UTP cable, Straight cabling, 0.5m
- Grey / green polycarbonate shell, UTP cable, Straight cabling, 1.0m
- Grey / green polycarbonate shell, UTP cable, Straight cabling, 2.0m
- Grey / green polycarbonate shell, UTP cable, Straight cabling, 3.0m

PVC Sheath - 4 Pair

- Grey / green polycarbonate shell, UTP cable, Straight cabling, 1.0m
- Grey / green polycarbonate shell, UTP cable, Straight cabling, 2.0m
- Grey / green polycarbonate shell, UTP cable, Straight cabling, 3.0m

- P29811A5
- P29812A5

- P39813A5
- P39814A5
- P39815A5
- P39819A5

- P39816A5
- P39817A5
- P39818A5

Copper Components

Description	Ref.-No
<i>PVC Sheath - 7 - 8 cabling - 1 Pair</i>	
Grey / green polycarbonate shell, UTP cable, Straight cabling, 1.0m	P39827F5
Grey / green polycarbonate shell, UTP cable, Straight cabling, 2.0m	P39827A5
<i>PVC Sheath - 4 - 5 cabling - 1 Pair</i>	
Grey / green polycarbonate shell, UTP cable, Straight cabling, 1.0m	P39829F5
Grey / green polycarbonate shell, UTP cable, Straight cabling, 2.0m	P39829A5
<i>LSOH Sheath - 568A cabling - 2 Pair</i>	
Grey / green polycarbonate shell, UTP cable, Straight cabling, 0.5m	P39362D5
Grey / green polycarbonate shell, UTP cable, Straight cabling, 1.0m	P39362F5
Grey / green polycarbonate shell, UTP cable, Straight cabling, 2.0m	P39362A5
<i>LSOH Sheath - 568A cabling - 4 Pair</i>	
Grey / green polycarbonate shell, UTP cable, Straight cabling, 2.0m	P39364A5
<i>PVC Sheath - 568A cabling - 2 Pair</i>	
Grey / green polycarbonate shell, UTP cable, Straight cabling, 0.5m	P39824D5
Grey / green polycarbonate shell, UTP cable, Straight cabling, 1.0m	P39824A5
Grey / green polycarbonate shell, UTP cable, Straight cabling, 2.0m	P39825A5
<i>PVC Sheath - 568A cabling - 4 Pair</i>	
Grey / green polycarbonate shell, UTP cable, Straight cabling, 0.5m	P39826D5
Grey / green polycarbonate shell, UTP cable, Straight cabling, 2.0m	P39826A5
Quante™ CBE - CBE FTP Patch Cords	
<i>PVC Sheath - 1 Pair</i>	
Grey / green polycarbonate shells, FTP cable, drain connected to earth Straight cabling, 1.0m	P29361A5
Grey / green polycarbonate shells, FTP cable, drain connected to earth Straight cabling, 2.0m	P29362A5
<i>PVC Sheath - 2 Pair</i>	
Grey / green polycarbonate shells, FTP cable, drain connected to earth Straight cabling, 1.5m	P39472A5
Grey / green polycarbonate shells, FTP cable, drain connected to earth Straight cabling, 2.0m	P39482A5
Grey / green polycarbonate shells, FTP cable, drain connected to earth Straight cabling, 3.0m	P39492A5
<i>PVC Sheath - 4 Pair</i>	
Grey / green polycarbonate shells, FTP cable, drain connected to earth Straight cabling, 1.0m	P39474A5
Grey / green polycarbonate shells, FTP cable, drain connected to earth Straight cabling, 2.0m	P39484A5
Grey / green polycarbonate shells, FTP cable, drain connected to earth Straight cabling, 3.0m	P39494A5
Quante™ CBE - RJ45 FTP Patch Cords (drain connected to earth cabling EIA/TIA 568A)	
<i>PVC Sheath - 568A cabling - 2 Pair</i>	
Grey / green polycarbonate shells and 9-pin RJ45, FTP cable, 0.5m	P39370D5
Grey / green polycarbonate shells and 9-pin RJ45, FTP cable, 2.0m	P39370A5
Grey / green polycarbonate shells and 9-pin RJ45, FTP cable, 3.0m	P39372A5
<i>PVC Sheath - 568A cabling - 4 Pair</i>	
Grey / green polycarbonate shells and 9-pin RJ45, FTP cable, 2.0m	P39374D5
Grey / green polycarbonate shells and 9-pin RJ45, FTP cable, 2.0m	P39374A5
Grey / green polycarbonate shells and 9-pin RJ45, FTP cable, 3.0m	P39376A5
Quante™ CBE - CBE SFTP Patch Cords	
<i>LSOH Sheath - 1 Pair</i>	
Metal Shell, SFTP cable, 360° connection to cable screen, Straight cabling, 0.5m	P39125D5
Metal Shell, SFTP cable, 360° connection to cable screen, Straight cabling, 1.0m	P39125A5
Metal Shell, SFTP cable, 360° connection to cable screen, Straight cabling, 2.0m	P39135A5
Metal Shell, SFTP cable, 360° connection to cable screen, Straight cabling, 3.0m	P39135J5
Metal Shell, SFTP cable, 360° connection to cable screen, Straight cabling, 4.0m	P39135L5
Metal Shell, SFTP cable, 360° connection to cable screen, Straight cabling, 5.0m	P39135M5

Copper Components

Description	Ref.-No
<i>LSOH Sheath - 2 Pair</i>	
Metal Shell, SFTP cable, 360° connection to cable screen, Straight cabling, 0.5m	P39116A5
Metal Shell, SFTP cable, 360° connection to cable screen, Straight cabling, 1.0m	P39126A5
Metal Shell, SFTP cable, 360° connection to cable screen, Straight cabling, 2.0m	P39136A5
Metal Shell, SFTP cable, 360° connection to cable screen, Straight cabling, 3.0m	P39146A5
Metal Shell, SFTP cable, 360° connection to cable screen, Straight cabling, 4.0m	P39146L5
Metal Shell, SFTP cable, 360° connection to cable screen, Straight cabling, 5.0m	P39146M5
<i>LSOH Sheath - 4 Pair</i>	
Metal Shell, SFTP cable, 360° connection to cable screen, Straight cabling, 0.5m	P39128D5
Metal Shell, SFTP cable, 360° connection to cable screen, Straight cabling, 1.0m	P39128A5
Metal Shell, SFTP cable, 360° connection to cable screen, Straight cabling, 2.0m	P39138A5
Metal Shell, SFTP cable, 360° connection to cable screen, Straight cabling, 3.0m	P39148A5
Metal Shell, SFTP cable, 360° connection to cable screen, Straight cabling, 4.0m	P39148L5
Metal Shell, SFTP cable, 360° connection to cable screen, Straight cabling, 5.0m	P39148M5
<i>PVC Sheath- 1 Pair</i>	
Metal Shell, SFTP cable, 360° connection to cable screen, Straight cabling, 0.5m	P39801A5
Metal Shell, SFTP cable, 360° connection to cable screen, Straight cabling, 1.0m	P39802A5
<i>PVC Sheath- 2 Pair</i>	
Metal Shell, SFTP cable, 360° connection to cable screen, Straight cabling, 0.5m	P39803A5
Metal Shell, SFTP cable, 360° connection to cable screen, Straight cabling, 1.0m	P39804A5
Metal Shell, SFTP cable, 360° connection to cable screen, Straight cabling, 2.0m	P39805A5
Metal Shell, SFTP cable, 360° connection to cable screen, Straight cabling, 3.0m	P39809A5
<i>PVC Sheath- 4 Pair</i>	
Metal Shell, SFTP cable, 360° connection to cable screen, Straight cabling, 1.0m	P39806A5
Metal Shell, SFTP cable, 360° connection to cable screen, Straight cabling, 2.0m	P39807A5
Metal Shell, SFTP cable, 360° connection to cable screen, Straight cabling, 3.0m	P39808A5
Quante™ CBE - RJ45 SFTP Patch Cords	
<i>LSOH Sheath- 7 - 8 cabling - 1 Pair</i>	
Metal Shell, SFTP cable, 360° connection to cable screen, 1.0m	P39378F5
Metal Shell, SFTP cable, 360° connection to cable screen, 2.0m	P39378A5
<i>LSOH Sheath- 4 - 5 cabling - 1 Pair</i>	
Metal Shell, SFTP cable, 360° connection to cable screen, 1.0m	P39380F5
Metal Shell, SFTP cable, 360° connection to cable screen, 2.0m	P39380A5
<i>LSOH Sheath- 568A cabling - 2 Pair</i>	
Metal Shell, SFTP cable, 360° connection to cable screen, 2.0m	P39366A5
<i>LSOH Sheath- 568A cabling - 4 Pair</i>	
Metal Shell, SFTP cable, 360° connection to cable screen, 2.0m	P39368A5
<i>PVC Sheath- 568A cabling - 2 Pair</i>	
Metal Shell, SFTP cable, 360° connection to cable screen, 2.0m	P39821A5
Metal Shell, SFTP cable, 360° connection to cable screen, 2.0m	P39822A5
<i>LSOH Sheath- 568A cabling - 4 Pair</i>	
Metal Shell, SFTP cable, 360° connection to cable screen, 2.0m	P39823A5
Quante™ CBE - CBE Patch Cords - Cross Cabled	
<i>PVC Sheath - 2 Pair</i>	
Orange / grey polycarbonate shell, UTP cable, 1.0m	P39835A5
Orange / grey polycarbonate shell, UTP cable, 2.0m	P39836A5
<i>PVC Sheath - 4 Pair</i>	
Orange / grey polycarbonate shell, UTP cable, 1.0m	P39837A5
Orange / grey polycarbonate shell, UTP cable, 2.0m	P39838A5

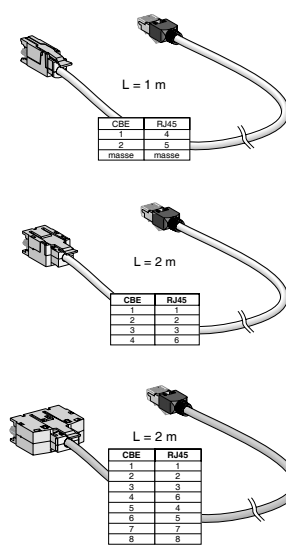

Copper Components

Description	Ref.-No
Quante™ CBE Patch Cords with circuit	
PVC Sheath - 1 Pair	
UTP cable, 1.0m	P29320A5
PVC Sheath - 2 Pair	
UTP cable, 1.0m	P29332F5
UTP cable, 2.0m	P29332A5

CDB - Copper Distribution Boxes

3M™ VKA Distribution Boxes for 60-640 pairs

VKA 2 / DIN-SID-C strips of 10 pairs (SID-C)	52-300-00025
VKA 4 / DIN-SID-C 6 strips of 20 pairs (SID-CD) or 16 strips of 10 pairs (SID-C)	52-300-00100
VKA 8 / DIN-SID-C 12 strips of 20 pairs (SID-C) or 32 strips of 10 pairs (SID-C)	52-300-00200
VKA 12 / DIN-SID-C 24 strips of 20 pairs (SID-CD) or 64 strips of 10 pairs (SID-C)	52-300-00300



Backmount Frames

SID-C Backmount Frame 100 pairs for 17.5mm	79148-518 00
SID-C Backmount Frame 200 pairs for 17.5mm	79148-519 00
SID-C Backmount Frame 100 pairs for 22.5mm	79148-523 00
SID-C Backmount Frame 200 pairs for 22.5mm	79148-524 00

Miscellaneous

Description	Ref.-No
CK - Cleaning Kit	
VF-45™ Maintenance Cleaning Kit VF-45™ Cleaning Fluid, 16 oz. bottle VF-45™ Mechanical Plug Cleaner Cleaning Tissues for Plug Cleaner VF-45™ Maintenance Cleaning Kit for Keyed Sockets and Plugs	VOL-0570 VOL-0570A VOL-0570B VOL-0570C VOL-0573
	
TKA - Tools, Kits and Accessories	
Copper	
Extraction tool SID™ Termination tool Impact tool for IDC system STG, QSA and System 71	79397-515 00 79397-512 00 C234037A
	
Fibre	
VF-45™ Quick install Termination Kit ST Reference cable test 50um SC Reference cable test 50um ST Reference cable test 62,5um SC Reference cable test 62,5um Fibrlok™ Assembly tool Fibrlok™ splice preparation kit with T&B Cleaving tool Fibrlok™ splice preparation kit without T&B Cleaving tool Multi-fibre optical splice preparation kit (220V) Multi-fibre ribbon construction tool kit Universal Hot Melt Termination Kit for ST, SC and FC (230V) Universal Crimplok™ Termination Kit for ST and SC 230V Europe w/Power Supply	VOL-0562 GEN-REF 050-ST GEN-REF 050-SC GEN-REF 062-ST GEN-REF 062-SC 2501 2530 2531 2601 2670 6351 6955 6851E
	
MC - Media Converters	
Workstation Media Converters	
10 Base T-10 Base FL Media Converter (PC Version) EU 10 Base T-10 Base FL Media Converter (PC Version) UK 10 Base T-10 Base FL Media Converter (PC Version) w/o Power Supply Power Supply with UK Net adapter Power Supply with EU Net adapter 100 Base-FX, 1300nm, EU 100 Base-FX, 1300nm, UK 100 Base-FX, 1300nm, W/O Power Supply	VOL-0201- EU VOL-0201- UK VOL-0201-X VOL-0201-PS-EU VOL-0201-PS-UK VOL-M100FX-U VOL-M100FX-UK VOL-M100FX-X
	
19" Rack Mount Media Converters	
6 Port, 10 Base-T - 10 Base-FL, EU+UK Powercord Kit 12 Port, 10 Base-T - 10 Base-FL, EU+UK Powercord Kit 24 Port, 10 Base-T - 10 Base-FL, EU+UK Powercord Kit 12 Port, 100 Base-FX, 1300nm, EU 12 Port, 100 Base-FX, 1300nm, UK 12 Port, 100 Base-FX, 1300nm, Universal Power Kit	VOL-M10FL-06 VOL-M10FL-12 VOL-0202 KIT VOL-M100FX-12-EUR VOL-M100FX-12-UK VOL-M100FX-12-X
	
SW - Switches	
Switch 8 port 10/100TX RJ45 w/ 100FX VF-45™ Uplink	VOL-1081
	